

**LUDLUM MODEL 4404-16-4
GEO-EXPLORATION COUNTER**

ADDENDUM TO MODEL 4404-16 Manual

July 2024

**Serial Number 246666 and Succeeding
Serial Numbers**

**LUDLUM MODEL 4404-16-4
GEO-EXPLORATION COUNTER**

ADDENDUM TO MODEL 4404-16 Manual

July 2024

**Serial Number 246666 and Succeeding
Serial Numbers**



LUDLUM MEASUREMENTS, INC.
501 OAK STREET, P.O. BOX 810
SWEETWATER, TEXAS 79556
325-235-5494, FAX: 325-235-4672

STATEMENT OF WARRANTY

Ludlum Measurements, Inc. warrants the products covered in this manual to be free of defects due to workmanship, material, and design for a period of twelve months from the date of delivery. The calibration of a product is warranted to be within its specified accuracy limits at the time of shipment. In the event of instrument failure, notify Ludlum Measurements to determine if repair, recalibration, or replacement is required.

This warranty excludes the replacement of photomultiplier tubes, G-M and proportional tubes, and scintillation crystals which are broken due to excessive physical abuse or used for purposes other than intended.

There are no warranties, express or implied, including without limitation any implied warranty of merchantability or fitness, which extend beyond the description of the face there of. If the product does not perform as warranted herein, purchaser's sole remedy shall be repair or replacement, at the option of Ludlum Measurements. In no event will Ludlum Measurements be liable for damages, lost revenue, lost wages, or any other incidental or consequential damages, arising from the purchase, use, or inability to use product.

RETURN OF GOODS TO MANUFACTURER

If equipment needs to be returned to Ludlum Measurements, Inc. for repair or calibration, please send to the address below. All shipments should include documentation containing return shipping address, customer name, telephone number, description of service requested, and all other necessary information. Your cooperation will expedite the return of your equipment.

**LUDLUM MEASUREMENTS, INC.
ATTN: REPAIR DEPARTMENT
501 OAK STREET
SWEETWATER, TX 79556**

**800-622-0828 325-235-5494
FAX 325-235-4672**

LUDLUM MEASUREMENTS, INC.

501 OAK ST. / P.O. BOX 810

SWEETWATER, TEXAS 79556

Phone: 325-235-5494 800-622-0828 (USA)

Fax: 325-235-4672 E-Mail: ludlum@ludlums.comWebsite: <http://www.ludlums.com> FEIN 75-1085764**DESIGNER AND MANUFACTURER****OF***Scientific and Industrial
Instruments*

**Model 4404-16-4
Addendum to the Model 4404-16 manual
June 2011**

The Model 4404-16-4 operates in the same way as the Model 4404-16. The difference is that the 4404-16-4 has a smaller NaI scintillation detector, requiring a smaller carrying case. The case enclosure for this particular instrument can fit into a backpack and be carried by hand, whereas the case for the Model 4404-16 is 102 cm (40 in.) long, has wheels for transporting, and weighs 18.1 kg (40 lb).

Model 4404-16-4 Detector Size: 7.6 x 7.6 cm (3 x 3 in.)

Model 4404-16-4 Case (Enclosure) Dimensions: 29.2 x 36.3 x 16.5 cm (11.5 x 14.3 x 6.5 in.) (H x W x L)

Model 4404-16-4 Case (Enclosure) Weight: 5.7 kg (12.5 lb)

Table of Contents

INTRODUCTION.....	1
SOFTWARE INSTALLATION.....	3
Computer Specifications	4
Connecting a Computer	4
Starting Software	4
Settings.....	4
General.....	5
Plateau.....	6
Scaler Count Time	7
Rate Meter	8
End User License Agreement.....	9
SOFTWARE FEATURES	12
Counting.....	13
Charting.....	14
Logging Data	16
Channel Colors.....	17
Calibration.....	17
High Voltage	18
Lower Level Discriminator	19
Upper Level Discriminator	20
Efficiency	21
Mode.....	22
Calibration Wizard.....	23
HV Actual Calibration Constant.....	23
HV Read Back Calibration Constant.....	26
LLD Actual Calibration Constant.....	27
ULD Actual Calibration Constant	28
HV Plateau.....	29

Table of Contents cont.

ROI Configuration.....	30
Change Serial Number	31
Setup Comments	32
KML Generator	34
HARDWARE SPECIFICATIONS	35
DESCRIPTION OF CONTROLS AND FUNCTIONS.....	36
DRAWINGS AND DIAGRAMS	37
HARDWARE CALIBRATION.....	53
RS-232 COMMUNICATION	55
 RS-232 Commands.....	57

Section

1

Introduction

The Ludlum Model 4404-16 Geo-Exploration System provides radiation surface measurements to help discern the underlying geology. It utilizes a large scintillation detector, the Ludlum Model 4404-16 multichannel electronics, a waterproof enclosure, and a ruggedized laptop with integrated GPS (Global Positioning System). The software will display the radiation data just like a chart recorder and log the radiation data and GPS coordinates into a comma delimited file. The “KML Generator” software program converts the data files into files suitable from

viewing in Google Earth or any other 3D earth browser implementing the KML (Keyhole Markup Language) encoding.

Subsurface oil and gas fields have been mapped using surface radiation sensors since the 1950s. Radiation “anomalies” are created over such fields due to the vertical migration of hydrocarbons. While such readings may suggest or confirm the presence of underground fields, it is important to realize the limitations of these readings. It is not possible to tell either the depth or the ultimate productivity of a well or field. These radiation anomalies are not present over lakes or flooded areas. Ludlum Measurements cannot guarantee any conclusions or results based on the information provided by this system.

The Ludlum Model 4404-16 has additional uses. It may be used for radioactive ore prospecting. The settings may be customized for uranium or other radioactive isotopes. It may also be used for general radiation survey for radioactive contamination.

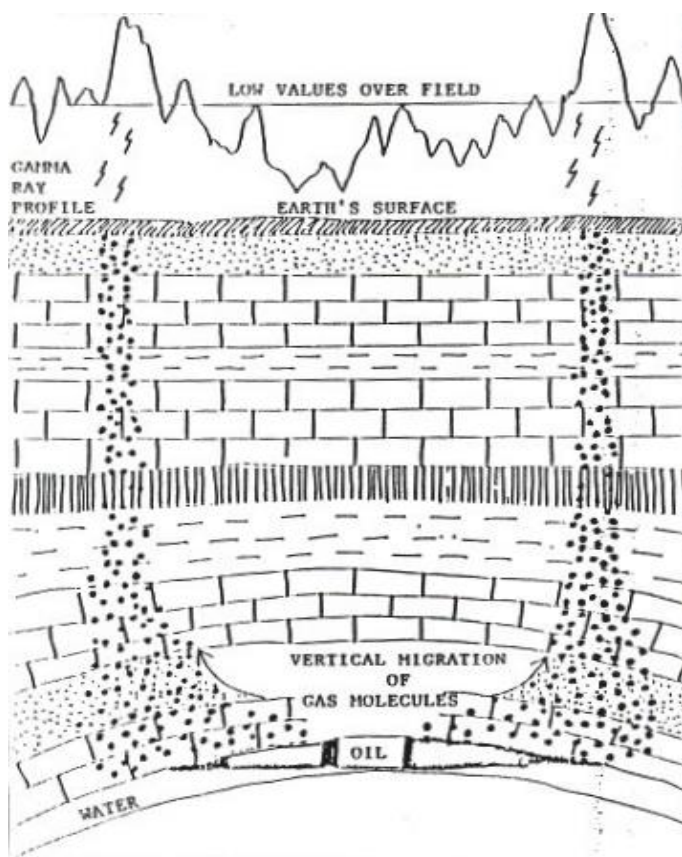

The Model 4404-16 electronics is mounted inside the detector enclosure and is configured with a host board and four slave boards providing separate radiation channels. The first channel is normally a gross counting channel providing data on radiation energies from 20 keV to 3 MeV. The other three channels can be set on selected regions of interest. For oil and gas exploration, for example, the three regions are based on:

$^{238}\text{Uranium}$: 0.61 MeV

$^{230}\text{Thorium}$: 2.62 MeV

$^{40}\text{Potassium}$: 1.46 MeV

The waterproof enclosure is designed to protect the sensitive sodium iodide (NaI) detector from damage. This detector is based on a scintillator crystal, which is sensitive to thermal or mechanical shock. The enclosure provides both thermal and mechanical cushioning to the detector. Use vibration isolators when mounting the enclosure to a vehicle or other structure. Do not subject the detector to rapid changes in temperature.

Section**2**

Software Installation

SYSTEM REQUIREMENTS

The Ludlum Model 4404 Geo-Exploration Counter software is a Windows™ program, intended to run on a IBM-compatible personal computer (PC) running Windows™ XP or later.

HARDWARE REQUIREMENTS

Windows™ based PC with an RS-232 serial port

USB-to-serial adapter may be required if the computer does not have an RS-232 serial port

MINIMUM PC REQUIREMENTS

1.2 GHz processor or greater

512 MB of memory (1024 MB recommended)

High capacity hard drive for storing the database

SVGA monitor capable of a resolution of 800 x 600 or greater

GPS utilizing a COMM port for communication capable of sending out NMEA messages every second.

INSTALLATION

Note:

Before installing any LMI software, read the software license agreement at the end of this section.

Insert the Model 4404-16 Geo-Exploration Counter CD (LMI Part # 1370-088) into your CD-ROM drive. If the installation does not start

automatically, double-click on “setup.exe” to start installation. After the installation is complete, a group will be created under the Start Menu called “Ludlum Measurements, Inc” with the Model 4404 Geo-Exploration Counter shortcut.

The KML Generator can be installed by running the setup.exe from the “KML Generator.”

Computer Specifications

Panasonic Toughbook Model CF-19 or equal (optional built-in GPS)

Full magnesium alloy case with hand strap

Scaled all-weather design

Power: Lithium battery pack, battery operation approximately nine hours

Size: 4.3 x 27.2 x 21.6 cm (1.9 x 10.7 x 8.5 in.) (H x W x L)

Weight: 2.3 kg (5.1 lb)

Connecting a Computer

Connect the Model 4404-16 Geo-Exploration Counter to the computer with the supplied RS-232 cable. Connect the cables from the detector to the slave board(s). The calibration paperwork will identify which detector should be connected to each channel. Connect the AC power adapter to the host board.

Starting Software

Click on this shortcut to start the software. The software will default to looking for the Counter on COMM Port 1 and the GPS on COMM Port 3. If the COMM Port is a different value, the correct port number must be selected from the Settings screen.

Settings

The Settings screen is accessed from the Tools/Settings menu and is used to configure the options that affect how the software operates.

General

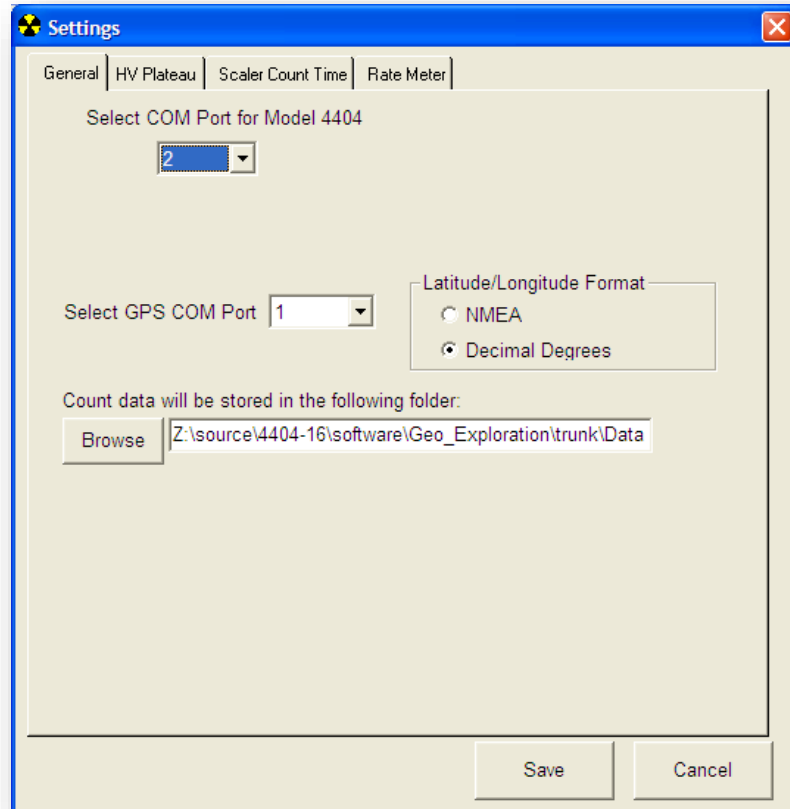

COM Port: The RS-232 serial port is used to communicate with the counter. This list box displays all available communication ports on the computer. If a USB-to-serial adapter is used, consult the documentation that came with it for instructions on installing any drivers and configuring the port.

GPS COM Port: The RS-232 serial port is used to communicate with the GPS. This list box displays all available communication ports on the computer. If a USB-to-serial adapter is used, consult the documentation that came with it for instructions on installing any drivers and configuring the port.

Latitude/Longitude Format: Specify the format of the GPS coordinates saved to data file. The choices are NMEA format and Decimal Degrees. The NMEA format is the default output by the GPS.

Decimal degrees are more suitable for programs such as Google Earth and other applications.

Data Folder: The count data is saved in this folder and can be located anywhere on the computer.

Plateau

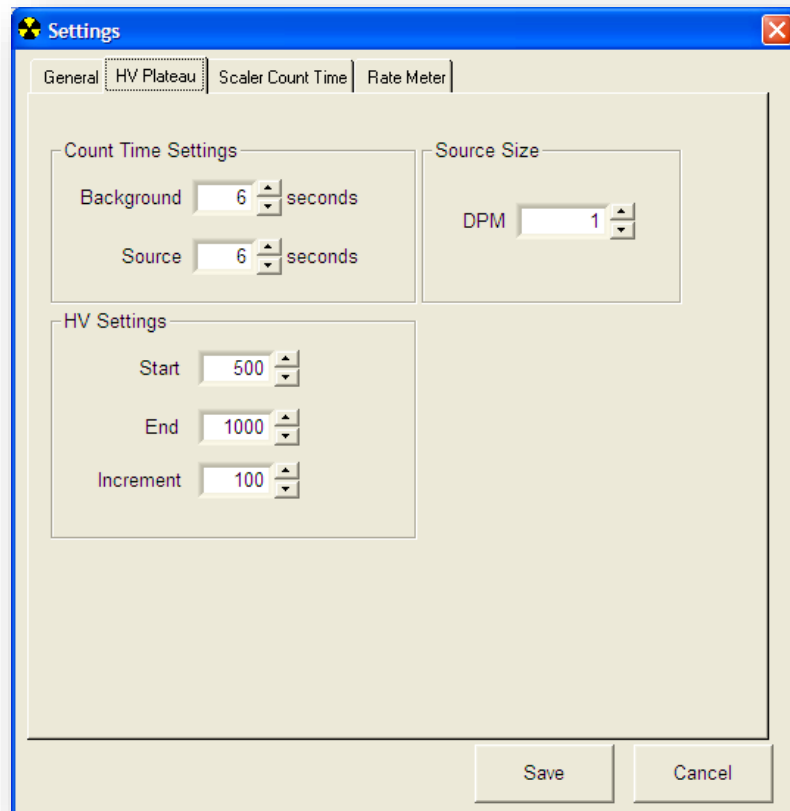

The plateau settings determine the default values used when running a plateau. These values can also be changed directly on the HV Plateau screen.

Count Time: The count time is in seconds for taking background and source counts.

Source Size: The source size is in DPM for calculating the efficiency.

HV Settings: This is the start, stop, and increment voltage. The high voltage will be set to the starting value and incremented by the increment value until the end high voltage is reached.

Scaler Count Time

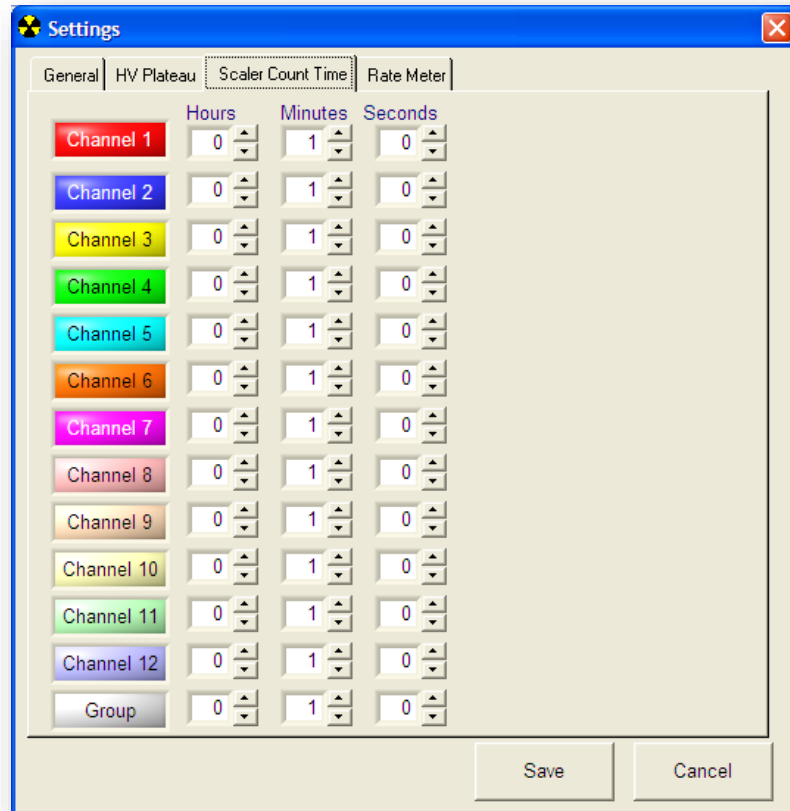

The scaler count time settings determine the default values used for the count times. These values can also be changed directly on the main screen.

Rate Meter

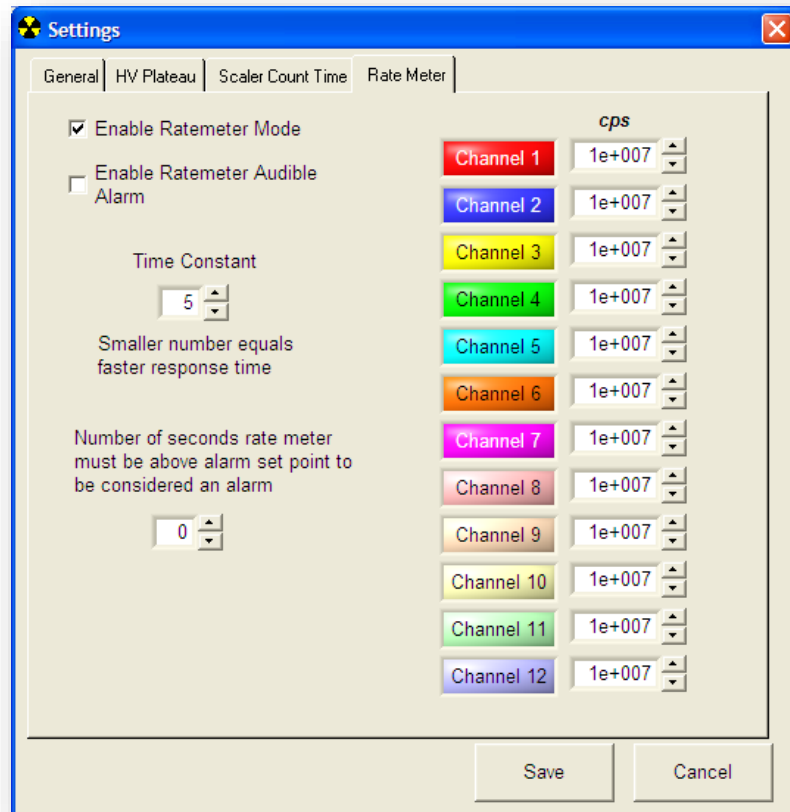

The rate meter settings determine if the rate meter is enabled and what the time constant will be when enabled. This setting affects the count values on the chart and the values saved to the data file. When disabled, the count is the raw one second count. The higher the time constant the slower the response time will be.

Individual alarm set points can be used to alert the user if the radiation exceeds a user-defined level. An audible alert can also be enabled. When a channel is alarming, its label on the graph legend is highlighted and the background on the count screen becomes red.

End User License Agreement



LUDLUM MEASUREMENTS, INC.
 501 OAK ST., P.O. BOX 810
 SWEETWATER, TX 79556
 325/235-5494 FAX: 325/235-4672

Software License Agreement

Rev. (number) 1.0

Written by (or Revised by):

Date: 20 Jan 06

Approved by:

Date: 20 Jan 06

BY INSTALLING THIS SOFTWARE, YOU ARE CONSENTING TO BE BOUND BY THIS AGREEMENT. IF YOU DO NOT AGREE TO ALL OF THE TERMS OF THIS AGREEMENT, DO NOT INSTALL THE PRODUCT.

Single User License Grant: Ludlum Measurements, Inc. ("Ludlum") and its suppliers grant to Customer ("Customer") a nonexclusive and nontransferable license to use the Ludlum software ("Software") in object code form solely on a single central processing unit owned or leased by Customer or otherwise embedded in equipment provided by Ludlum.

Customer may make one (1) archival copy of the Software provided Customer affixes to such copy all copyright, confidentiality, and proprietary notices that appear on the original.

EXCEPT AS EXPRESSLY AUTHORIZED ABOVE, CUSTOMER SHALL NOT: COPY, IN WHOLE OR IN PART, SOFTWARE OR DOCUMENTATION; MODIFY THE SOFTWARE; REVERSE COMPILE OR REVERSE ASSEMBLE ALL OR ANY PORTION OF THE SOFTWARE; OR RENT, LEASE, DISTRIBUTE, SELL, OR CREATE DERIVATIVE WORKS OF THE SOFTWARE.

Customer agrees that aspects of the licensed materials, including the specific design and structure of individual programs, constitute trade secrets and/or copyrighted material of Ludlum. Customer agrees not to disclose, provide, or otherwise make available such trade secrets or copyrighted material in any form to any third party without the prior written consent of Ludlum. Customer agrees to implement reasonable security measures to protect such trade secrets and copyrighted material. Title to Software and documentation shall remain solely with Ludlum.

LIMITED WARRANTY. Ludlum warrants that for a period of ninety (90) days from the date of shipment from Ludlum: (i) the media on which the Software is furnished will be

free of defects in materials and workmanship under normal use; and (ii) the Software substantially conforms to its published specifications. Except for the foregoing, the Software is provided AS IS. This limited warranty extends only to Customer as the original licensee. Customer's exclusive remedy and the entire liability of Ludlum and its suppliers under this limited warranty will be, at Ludlum or its service center's option, repair, replacement, or refund of the Software if reported (or, upon request, returned) to the party supplying the Software to Customer. In no event does Ludlum warrant that the Software is error free or that Customer will be able to operate the Software without problems or interruptions.

This warranty does not apply if the software (a) has been altered, except by Ludlum, (b) has not been installed, operated, repaired, or maintained in accordance with instructions supplied by Ludlum, (c) has been subjected to abnormal physical or electrical stress, misuse, negligence, or accident, or (d) is used in ultrahazardous activities.

DISCLAIMER. EXCEPT AS SPECIFIED IN THIS WARRANTY, ALL EXPRESS OR IMPLIED CONDITIONS, REPRESENTATIONS, AND WARRANTIES INCLUDING, WITHOUT LIMITATION, ANY IMPLIED WARRANTY OF MERCHANTABILITY, FITNESS FOR A PARTICULAR PURPOSE, NONINFRINGEMENT OR ARISING FROM A COURSE OF DEALING, USAGE, OR TRADE PRACTICE, ARE HEREBY EXCLUDED TO THE EXTENT ALLOWED BY APPLICABLE LAW.

IN NO EVENT WILL LUDLUM OR ITS SUPPLIERS BE LIABLE FOR ANY LOST REVENUE, PROFIT, OR DATA, OR FOR SPECIAL, INDIRECT, CONSEQUENTIAL, INCIDENTAL, OR PUNITIVE DAMAGES HOWEVER CAUSED AND REGARDLESS OF THE THEORY OF LIABILITY ARISING OUT OF THE USE OF OR INABILITY TO USE THE SOFTWARE EVEN IF LUDLUM OR ITS SUPPLIERS HAVE BEEN ADVISED OF THE POSSIBILITY OF SUCH DAMAGES. In no event shall Ludlum's or its suppliers' liability to Customer, whether in contract, tort (including negligence), or otherwise, exceed the price paid by Customer. The foregoing limitations shall apply even if the above-stated warranty fails of its essential purpose. SOME STATES DO NOT ALLOW LIMITATION OR EXCLUSION OF LIABILITY FOR CONSEQUENTIAL OR INCIDENTAL DAMAGES.

The above warranty DOES NOT apply to any beta software, any software made available for testing or demonstration purposes, any temporary software modules or any software for which Ludlum does not receive a license fee. All such software products are provided AS IS without any warranty whatsoever.

This License is effective until terminated. Customer may terminate this License at any time by destroying all copies of Software including any documentation. This License will terminate immediately without notice from Ludlum if Customer fails to comply with any provision of this License. Upon termination, Customer must destroy all copies of Software.

Software, including technical data, is subject to U.S. export control laws, including the U.S. Export Administration Act and its associated regulations, and may be subject to export or import regulations in other countries. Customer agrees to comply strictly with

all such regulations and acknowledges that it has the responsibility to obtain licenses to export, re-export, or import Software.

This License shall be governed by and construed in accordance with the laws of the State of Texas, United States of America, as if performed wholly within the state and without giving effect to the principles of conflict of law. If any portion hereof is found to be void or unenforceable, the remaining provisions of this License shall remain in full force and effect. This License constitutes the entire License between the parties with respect to the use of the Software.

Restricted Rights - Ludlum's software is provided to non-DOD agencies with RESTRICTED RIGHTS and its supporting documentation is provided with LIMITED RIGHTS. Use, duplication, or disclosure by the Government is subject to the restrictions as set forth in subparagraph "C" of the Commercial Computer Software - Restricted Rights clause at FAR 52.227-19. In the event the sale is to a DOD agency, the government's rights in software, supporting documentation, and technical data are governed by the restrictions in the Technical Data Commercial Items clause at DFARS 252.227-7015 and DFARS 227.7202. Manufacturer is Ludlum Measurements, Inc. 501 Oak Street Sweetwater, Texas 79556.

Section**3**

Software Features

The Model 4404-16 Geo-Exploration Counter Software has the following features, which will be detailed in-depth in this section:

- Utilizes GPS to store location with each count
- Chart count data in real time. Ability to chart a specific channel or all channels
- Rate meter mode with individual set points and audible alarm
- Set the high voltage (HV), lower level discriminator (LLD), upper level discriminator(ULD), efficiency, gamma mode, and window mode on each channel
- HV plateau for a single channel or all channels
- Calibration Wizard that guides the user through the steps necessary to calibrate the counter
- User-definable color for each channel indicator
- ROI configuration based on serial number
- Comments that can be added on the graph and saved to the data file
- Keyhole Markup Language (KML) generator converts comma-delimited files into KML files suitable for display in Google Earth, Global Mapper or any other 3D earth browser (geobrowser) that supports the KML encoding.

Counting

The Count tab displays the current count data for each channel. The counts are updated every one second.

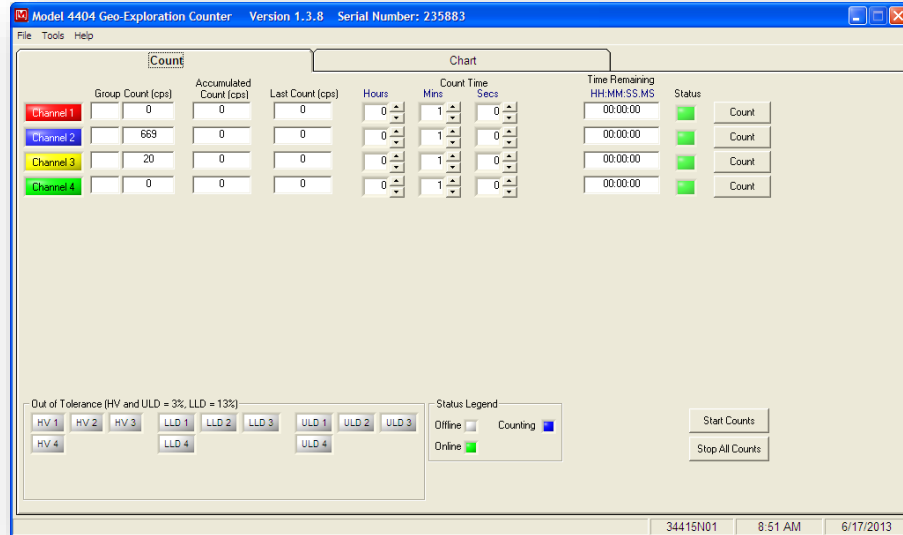

The main screen displays the following information: current one-second count, accumulated count, last count, status, and out-of-tolerance.

The Start Counts button displays a window allowing a group of channels to start counting simultaneously.

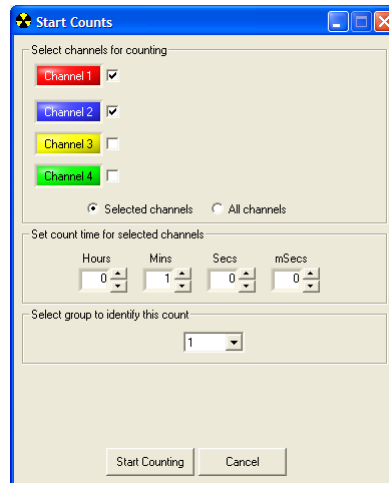

The status of the channel is displayed as a colored indicator next to the count button.

- Gray: Indicates the channel is offline. A channel may be offline if the channel does not exist or if there is a problem with the channel.
- Green: Indicates the channel is online and ready to start counting.
- Blue: Indicates the channel is counting. When the count time expires, the count is stopped.

Out-of-tolerance indicators in the lower left corner of the screen change to red if these parameters fall out of tolerance. The HV and ULD are out of tolerance if they are not within 3% of their set points. The LLD is out of tolerance if it is not within 13% of the set point. It is not possible to get an out-of-tolerance indication on channels that are configured for ROI operation.

Charting

When charting is enabled, a continuous plot of the channels selected is displayed on the graph. Charting is enabled by clicking the Start Charting button or pressing the F2 function key. The graph displays five minutes of data and is able to store up to two hours. To scroll back in time when the charting is stopped to see older data, left click on the graph's plot area and move the mouse to pan around the graph.



The current GPS coordinates are displayed along with the speed and date/time reported by the GPS receiver. A read out displays the selected channel's current count along with a minimum and maximum value large

enough to be seen easily from a distance. To reset the minimum and maximum values, click the Reset Min/Max button or press the F5 function key.

The current speed is added to the chart automatically at one minute intervals for reference.

While charting is enabled, click the Add Comment button or press the F4 function key to add a comment to the chart.

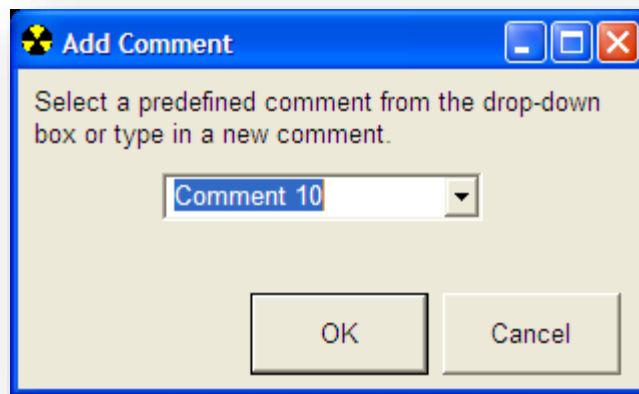

Select a pre-defined comment from the drop-down list box or type in a 20 character comment. The comment will be added to the chart as soon as the next one second reading is acquired. Comments are also stored in the data file.

The gain can be adjusted for each channel displayed on the chart screen. The gain only affects the displayed value and not the value saved to file. The displayed value is multiplied by the gain and can be useful in scaling a particular plot to make it more visible on screen.

Logging Data

Click on the “Start Logging” button or press the F3 function key to start logging data to a comma delimited text file. The “Save As” dialog box will be displayed asking for a file name to save the logged data. If the file already exists, data will be appended to it. If the file does not exist, it will be created. The file is saved in a comma separated value (.CSV) format. This is a text file where each value is separated by the comma character and is suitable for loading into a spreadsheet or database file for further processing, graphing, etc. This file contains the sample number, serial number, count date (12 channels), latitude, longitude, speed (knots), date and time in UTC, and comment.

Example:

```
Sample Number, Serial Number, Channel 1, Channel 2, Channel 3, Channel 4,
Channel 5, Channel 6, Channel 7, Channel 8, Channel 9, Channel 10, Channel
11, Channel 12, Latitude, Longitude, Speed (Knots), Date, Time, Comment,
Channel 1 / Channel 2, Channel 1 Alarm, Channel 2 Alarm, Channel 3 Alarm,
Channel 4 Alarm, Channel 5 Alarm, Channel 6 Alarm, Channel 7 Alarm,
Channel 8 Alarm, Channel 9 Alarm, Channel 10 Alarm, Channel 11 Alarm,
Channel 12 Alarm
```

Channel Colors

A color can be defined to help distinguish each channel. The channel indicators on all screens will be displayed with these colors as well as the plots on the graphs.

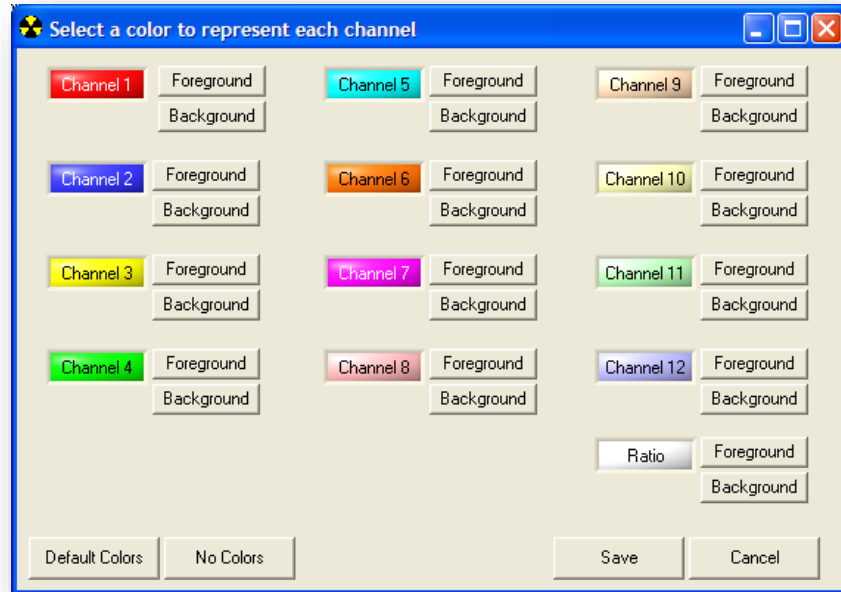

The foreground and background can be defined for each channel. Clicking on the “Default Colors” button will set each channel to a different default color. Clicking on the “No Colors” button will set all channels to white.

Calibration

The calibration screen allows the user to set the HV, LLD, ULD, efficiency, and modes for each channel. After changing a single or multiple values, click on the “Update Parameters” button to send the parameters to the counter. To reload the parameters from the counter, click on the “Refresh Parameters” button. The “Print” button will print a list of all parameters. The Calibration Wizard will guide the user through calibrating the various calibration constants for each channel. Only channels that are online are available for parameter changes.

High Voltage

The “High Voltage” tab shows the current high voltage set point, read back voltage, actual calibration constant, and read back calibration constant. The high voltage is adjustable from 0 to 1400 volts. The only values on this tab that can be changed are the high voltage set point. All other values must be changed through the Calibration Wizard. The high voltage can only be adjusted for channels that are configured for gross count operation.

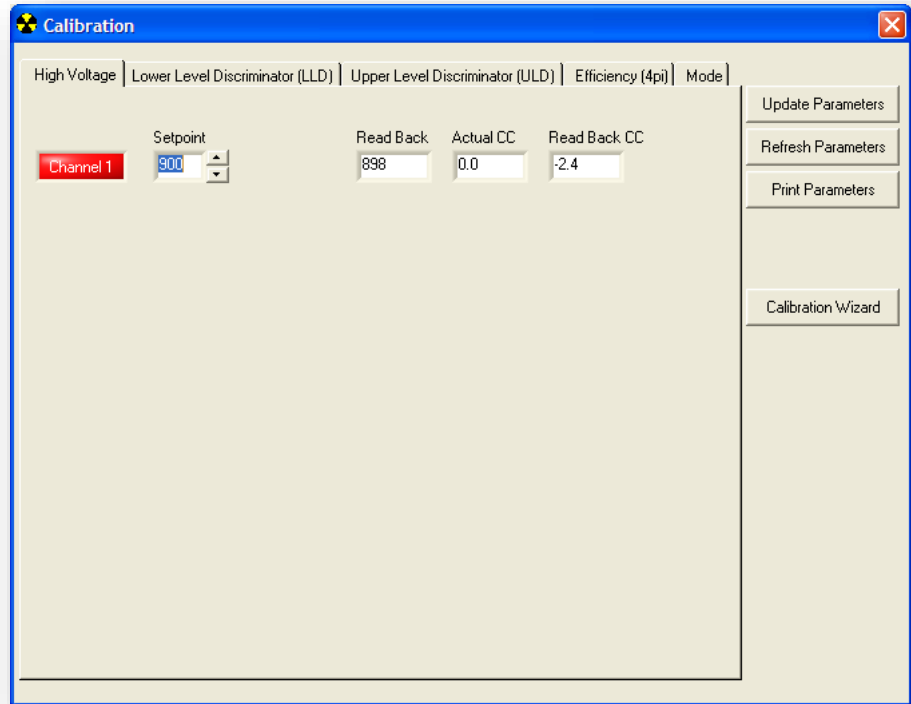

Lower Level Discriminator

The “Lower Level Discriminator” tab shows the current LLD set point, read back voltage, and actual calibration constant. The LLD is adjustable from 0 to 3300 millivolts.

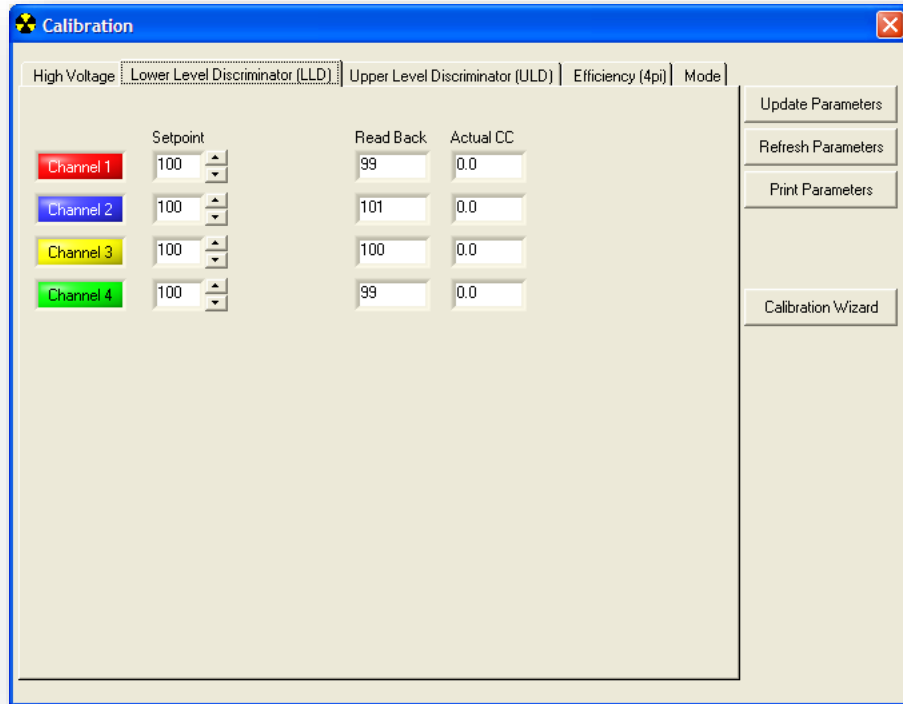

Upper Level Discriminator

The “Upper Level Discriminator” tab shows the current ULD set point, read back voltage, and actual calibration constant. The ULD is adjustable from 0 to 3300 millivolts.

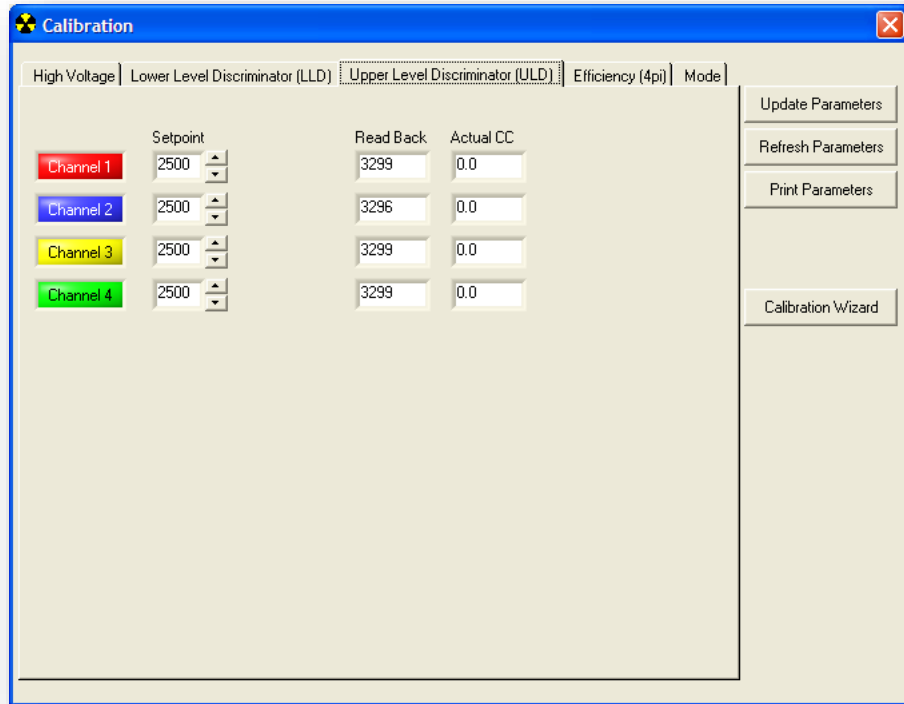

Efficiency

This is the efficiency calculated for the high voltage that was set when the plateau was run. It is not used for any calculations, but for informational purposes only.

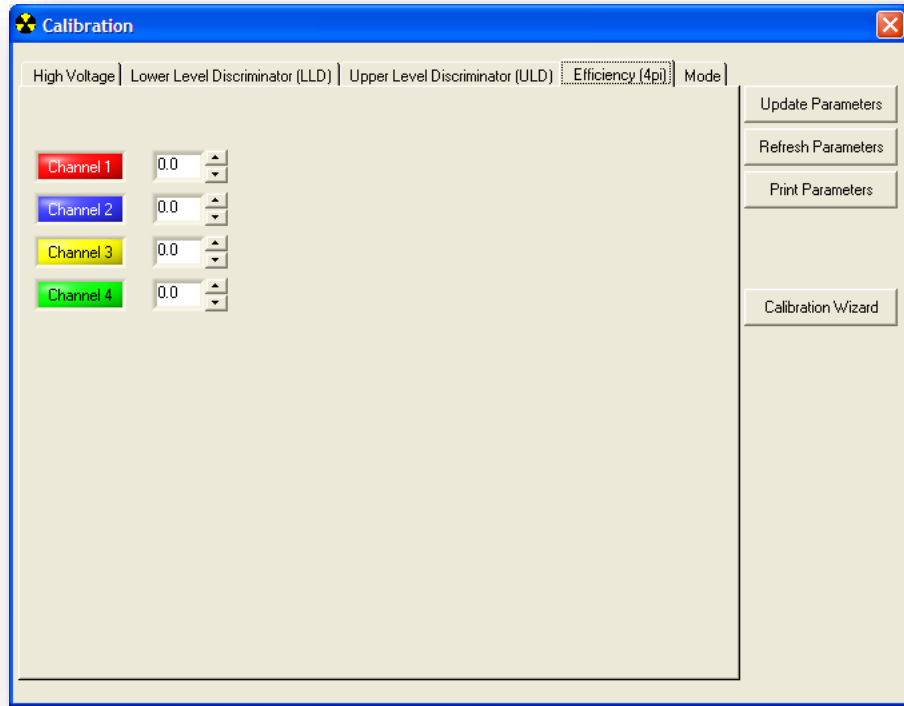

Mode

The GM and Window modes can be set individually for each channel. When the GM Mode is checked, the slave board is configured for use with GM detectors to eliminate double pulsing and long dead times. When the Window Mode is unchecked, the slave board's ULD set point is ignored.

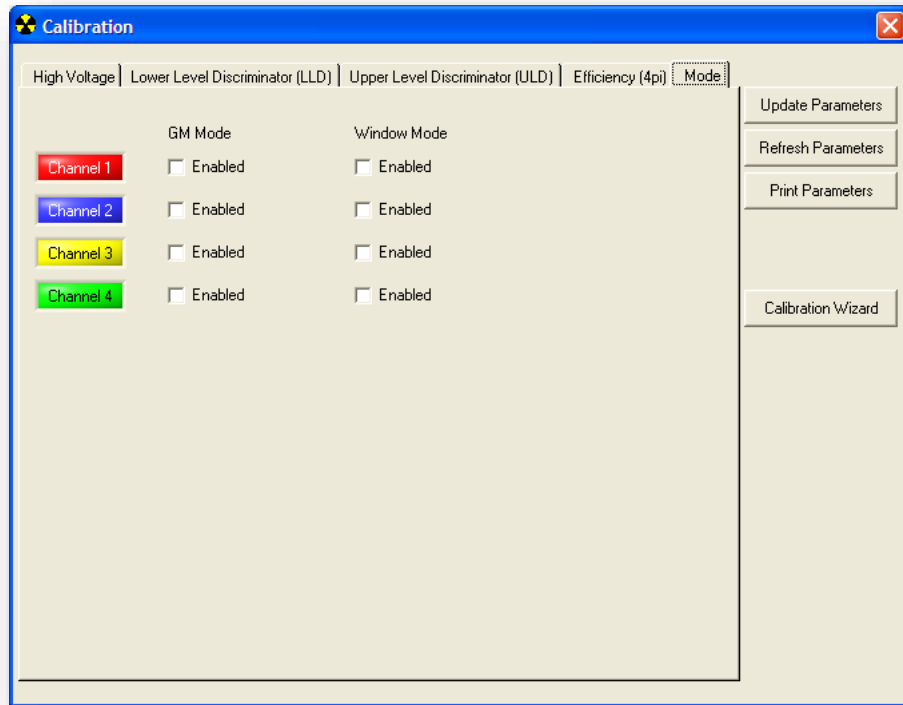

Calibration Wizard

The Calibration Wizard guides the user through the process of setting the calibration constants for each online channel. The following parameters will be set by the wizard: HV actual calibration constant, HV read back calibration constant, LLD actual calibration constant, and ULD actual calibration constant. The wizard automatically calculates the calibration constant based on the measurements entered in for each channel. All calibration constants are zeroed out at the beginning. Calibration requires a Model 500 Pulser with a high voltage readout or a high impedance voltmeter with at least 1000 Megohm meter input resistance.

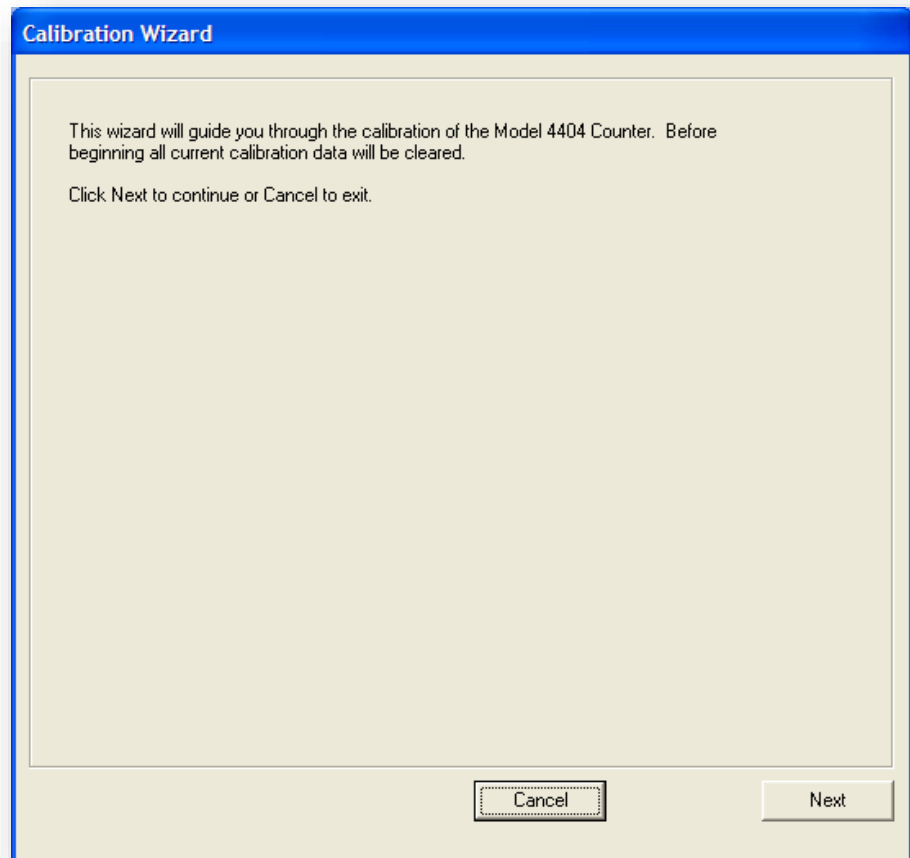

HV Actual Calibration Constant

Click the "Begin" button to start the process of calibrating the HV actual calibration constant. The HV actual calibration constant is calculated automatically by entering the high voltage measured at the detector

connector. The wizard will set the high voltage of all channels to zero and then prompt for the cable to be connected to the first channel. After connecting the cable and clicking “Next,” the high voltage will be restored to the set point. Enter the measured high voltage and click “Next.” This process continues until all online channels are completed. Click “Done” and then click “Next” to go to the HV read back calibration.

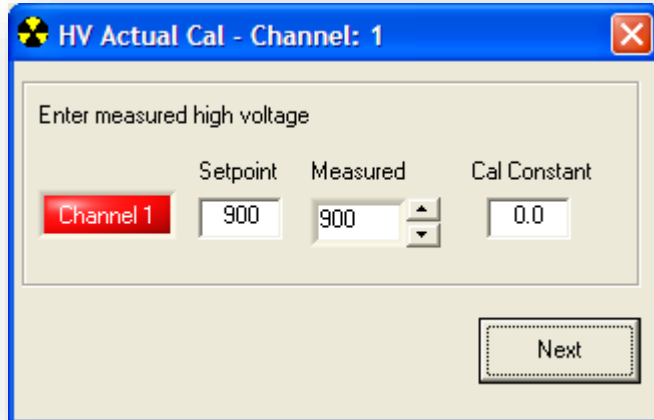
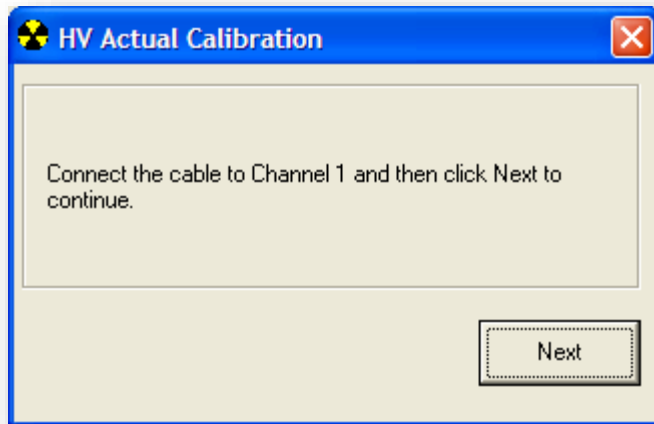

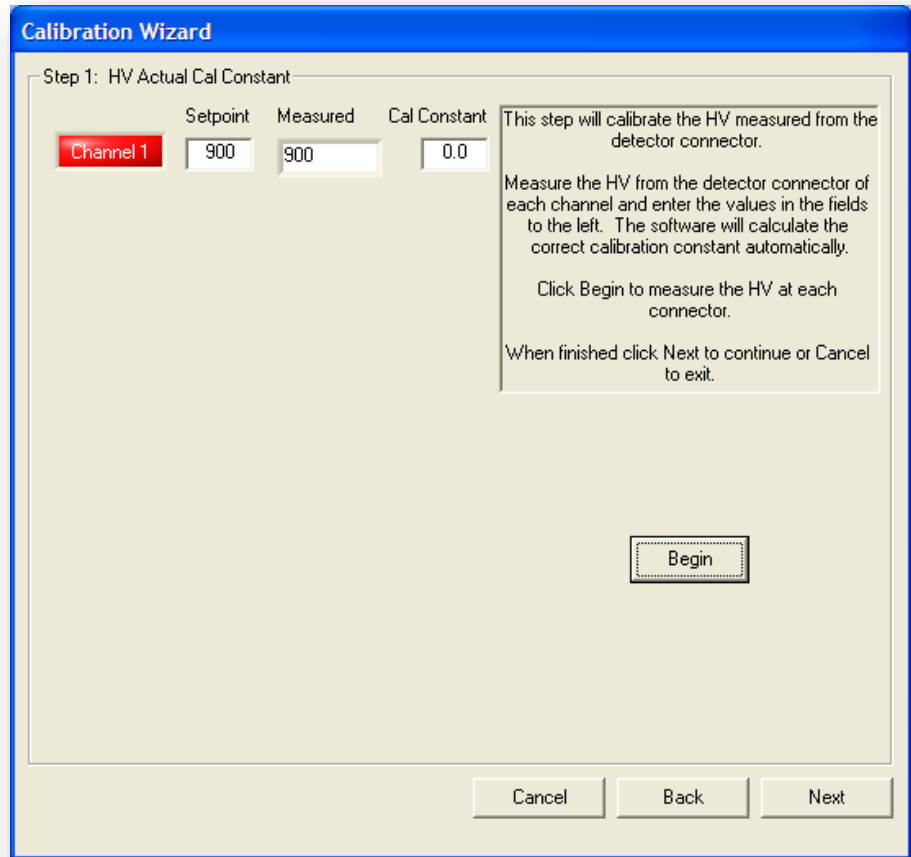

HV Read back Calibration Constant

The HV read back calibration constant is more or less automatic. Simply click on the “Reload” button to read the read back high voltage from the counter. If the returned values are consistent, click “Next.”

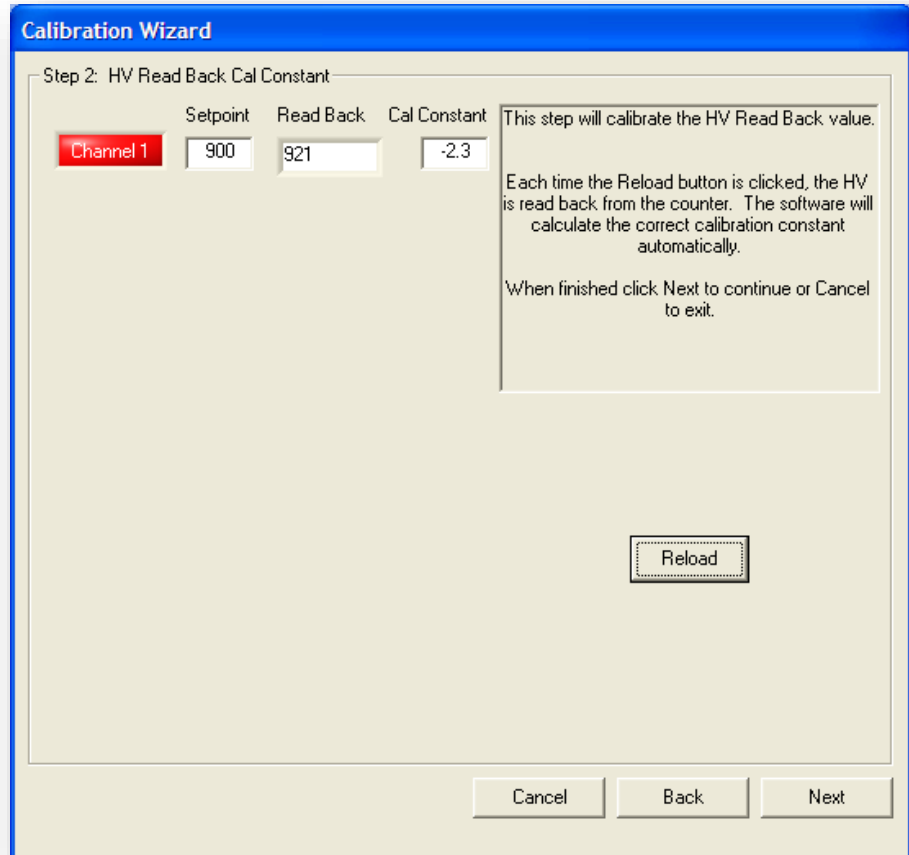

LLD Actual Calibration Constant

The LLD actual calibration constant is obtained by measuring the LLD from the test point on each channel and entering the measured reading in the appropriate fields. This can be accomplished by entering the number directly or using the up and down buttons to reach the desired value. When complete, click the “Next” button.

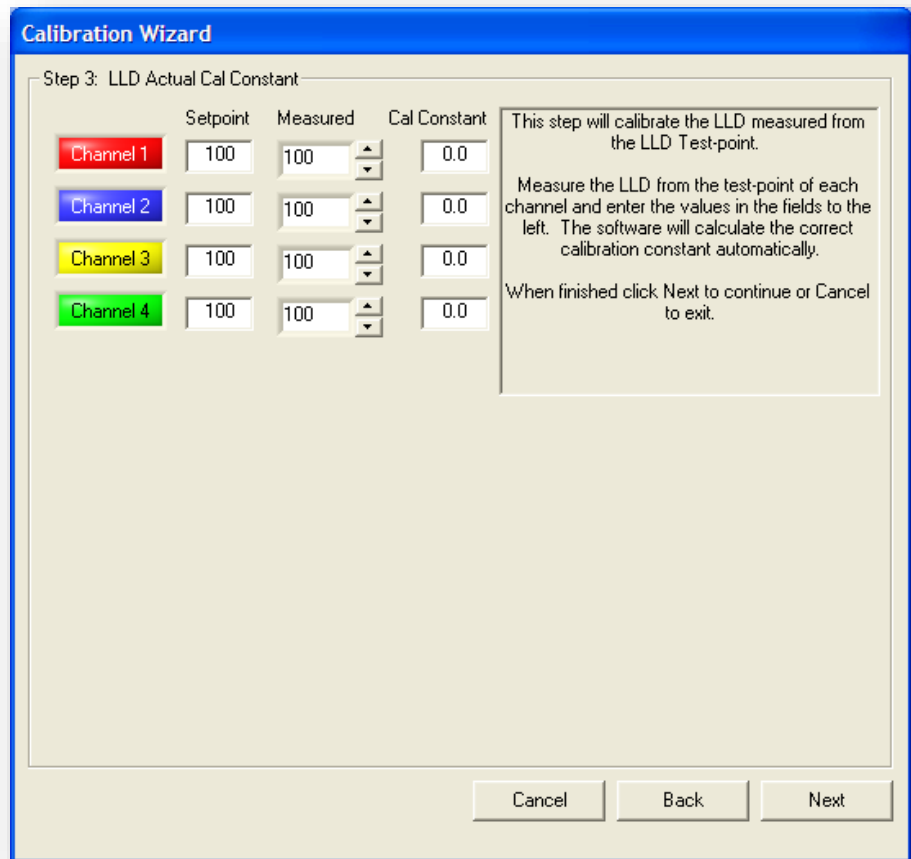

ULD Actual Calibration Constant

The ULD actual calibration constant is obtained by measuring the ULD from the test point on each channel and entering the measured reading in the appropriate fields. This can be accomplished by entering the number directly or using the up and down buttons to reach the desired value. When complete, click the “Next” button.

Calibration Wizard

Step 4: ULD Actual Cal Constant

	Setpoint	Measured	Cal Constant
Channel 1	2500	2500	0.0
Channel 2	2500	2500	0.0
Channel 3	2500	2500	0.0
Channel 4	2500	2500	0.0

This step will calibrate the ULD measured from the ULD Test-point.

Measure the ULD from the test-point of each channel and enter the values in the fields to the left. The software will calculate the correct calibration constant automatically.

When finished click Next to continue or Cancel to exit.

Cancel Back Next

HV Plateau

The HV plateau provides the ability to plateau individual or all channels simultaneously. Only channels configured for gross count operation can be plateaued. Before beginning, select which channels will be included in the plateau, background and source count times, start and ending high voltage, high voltage increment, and the source size in DPM. Clicking on the “Start” button will begin the plateau. The background plateau is run on all enabled channels simultaneously. After the background plateau is finished, the user will be prompted to place the source on the first detector. The user will then be prompted to place the source on the remaining detectors in sequence until all detectors have been plateaued.

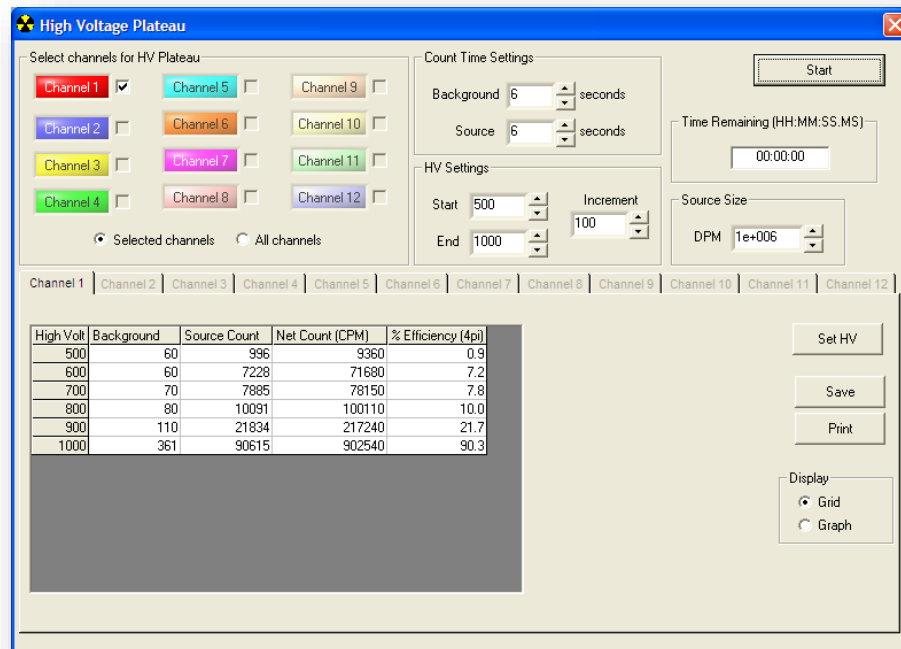

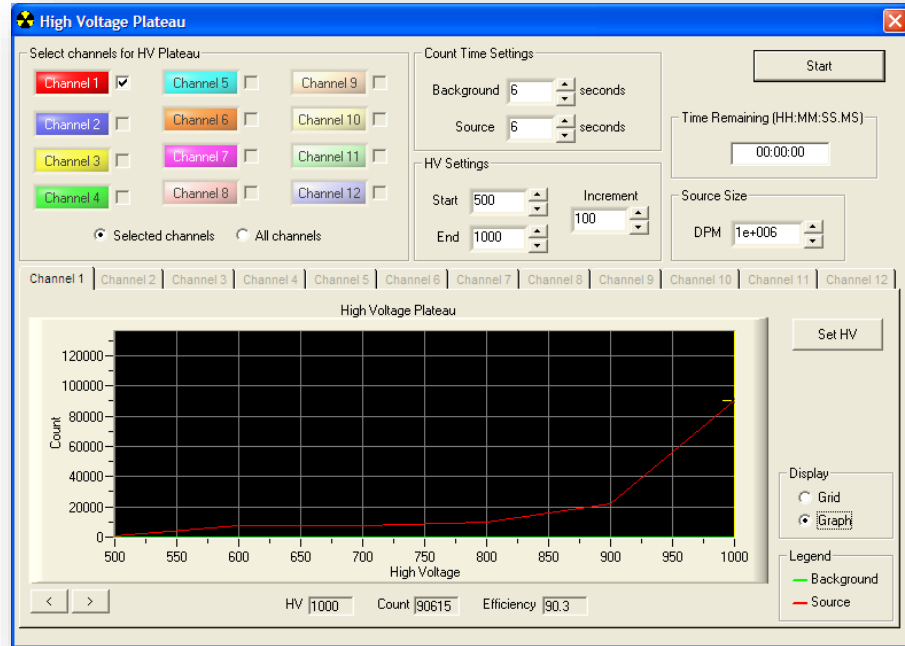

Once the plateau is complete, clicking on the “Set HV” button will set the high voltage and efficiency for the channel. Select the appropriate high voltage and efficiency by highlighting the row on the grid or by selecting a point on the graph with the cursor. On the graph view, the cursor can be moved by dragging it around the plot with the mouse or by using the “Cursor Left” and “Cursor Right” buttons, which are located at the bottom left corner of the graph.

ROI Configuration

The ROI Configuration screen is used to configure which channel is the master and which channels are the ROI slaves. The master channel is used to show the gross counts while the slave channels are used to see a specific Region Of Interest (ROI). A 12 character description can be added to each channel to provide easy identification of the ROI.



The Model 4404-16 is typically configured with 1 Master and 4 ROI slaves

Change Serial Number

The software provides for the ability to work with multiple Model 4404-16 counters with have different ROI configurations.

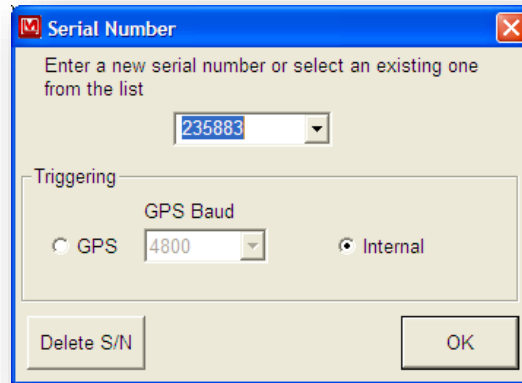

After connecting a different Model 4404-16, select Change Serial Number from the Tools menu and select the correct serial number from the drop-down list. If this is a new counter, enter in the serial number.

Two different types of triggering are available to get the counts from the Model 4404-16 Counter. GPS triggering uses the NMEA RMC message to trigger a reading from the Model 4404-16 every one second. When using the Model 4404-16 when a GPS signal is not available, for example when calibrating the instrument inside Internal triggering can be used. This uses an internal one second timer in the software to trigger a reading from the Model 4404-16.

Setup Comments

The screen provides the ability to setup a list of user-defined comments that can be added to the chart and saved to the data file to provide a short description of the current data. Fifty user-defined comments can be stored for quick access. It is also possible to add a comment from the Add Comments screen in addition to selecting an existing comment.

To change an existing comment, select it from the list on the left and change it. Click the Add button to add a new comment. Click the Delete button to delete the currently selected comment.

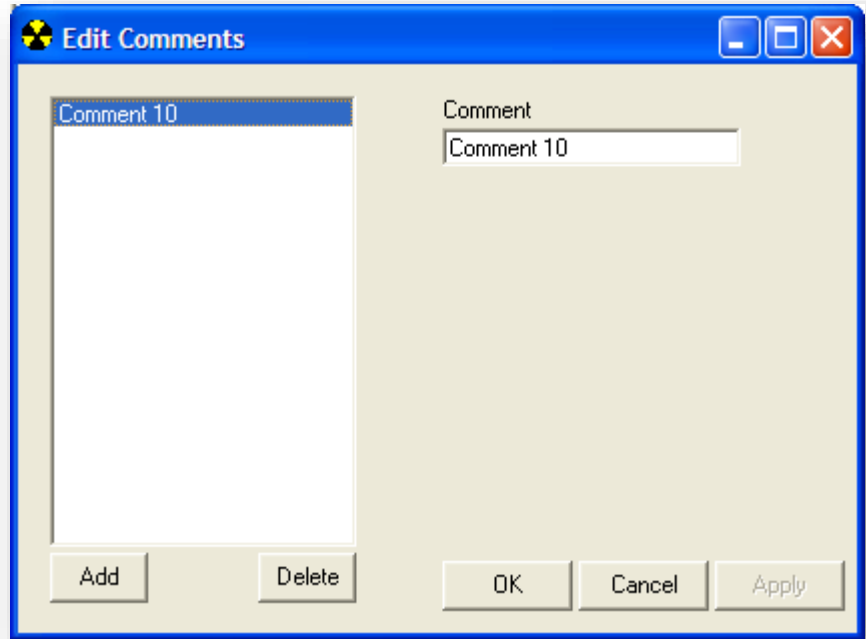

KML Generator

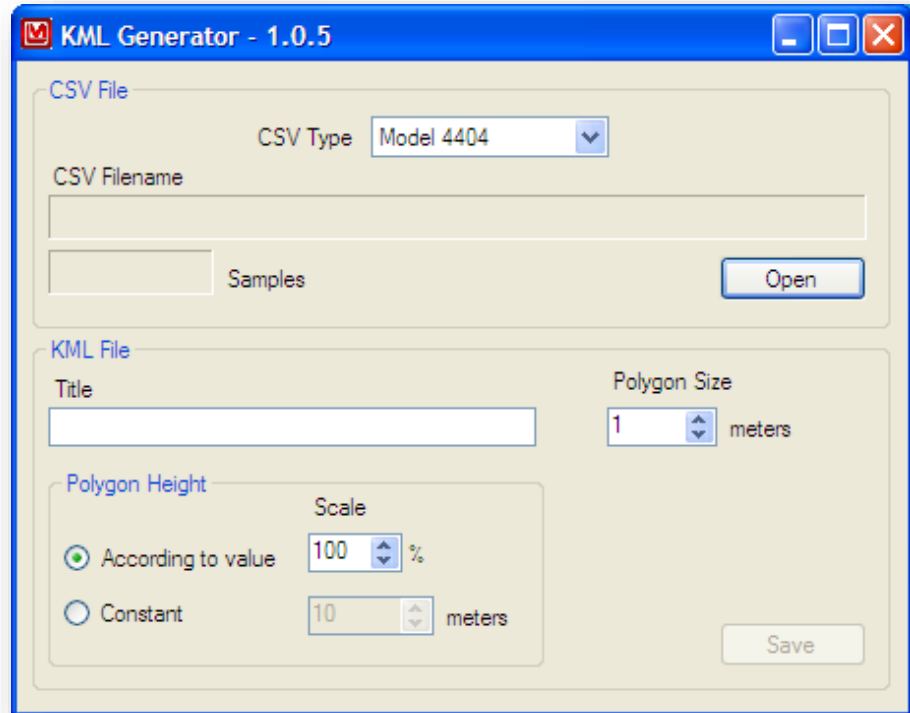

The KML Generator converts a Comma-Separated Value (.CSV) file into a Keyhole Markup Language (.KML) file.

To convert a .CSV file:

1. Select the type of file. Currently the KML Generator only supports data files from the Model 4404-16 Software.
2. Click the “Open” button to select and open a CSV file.
3. Set the parameters for the KML file and click the “Save” button.

Polygon Size: The size of the polygons used to represent the counts can be adjusted in size from 1 to 100 meters.

Height: The height of the polygons used to represent the counts can be based on the actual reading (1000 cps = 1000 meters) or all polygons can be set to a constant height. It is also possible to scale the height from 1% of full scale to 100%.

Section**4**

Hardware Specifications

Amplifier Gain: Adjustable from $\times 1$ to $\times 10$

Amplifier Range: 0-3.3 V

Input Sensitivity: Adjustable from 1 to 330 mV (detector signal)

High Voltage: Adjustable from 0 to 2000 Vdc

Window: Adjustable from 1 to 330 mV (detector signal)

Connectors: 4 BNC-type connectors (MHV also available)

Power: 7.5–36 Vdc at 50 mA max

Detector: 2 in D \times 4 in W \times 16 in L (5.1 cm \times 10.2 cm \times 40.6 cm) sodium iodide (NaI) with 3.5 in (8.9 cm) photomultiplier tube (PMT)

Enclosure (waterproof case): 17.8 x 43.2 x 101.6 cm (7 x 17 x 40 in.) (H x W x L)

Enclosure Weight: 18.1kg (40 lb)

Electronics Size: 10.9 x 29.2 x 10.7 cm (4.3 x 11.5 x 4.2 in.) (H x W x L)

Electronics Weight: 1.2 kg (2.7 lb)

Section
5

Description of Controls and Functions

Input: Voltage input; minimum 7.5 to maximum 35 Vdc, center pin is positive.

RS-232: Used in connecting the instrument to a computer, 8-N-1 19.2k bps, no handshaking.

Detectors 1-12: Up to 12 detectors may be connected depending on the chassis size.

Test Points: Each slave board has test point for upper level discriminator (ULD), lower level discriminator (LLD) and HV readback voltage (HR).

Amplifier Output: Each slave board has an SMB-type coaxial output for amplifier out. Use LMI part # 8303-632 (BNC to SMB).

Power LED: Red LED on front panel indicates unit power is on.
Note: Port connection and DTR must be high to activate this LED.

GN: Indicates gain adjustment for each slave board.
Note: At a normal gain setting of “10,” 500 mV on the LLD test point is equal to a 50 mV detector sensitivity.

Section**6**

Drawings and Diagrams

HOST -843 BOARD, Drawing 344 × 417 (3 sheets)

HOST -843 BOARD LAYOUT, Drawing 344 × 418A

SLAVE BOARD, Drawing 344 × 289 (3 sheets)

SLAVE AMP BOARD LAYOUT, Drawing 344 × 290A

SUB-SLAVE BOARD, Drawing 344 x 553 (3 sheets)

SUB-SLAVE BOARD LAYOUT, Drawing 344 x 554A

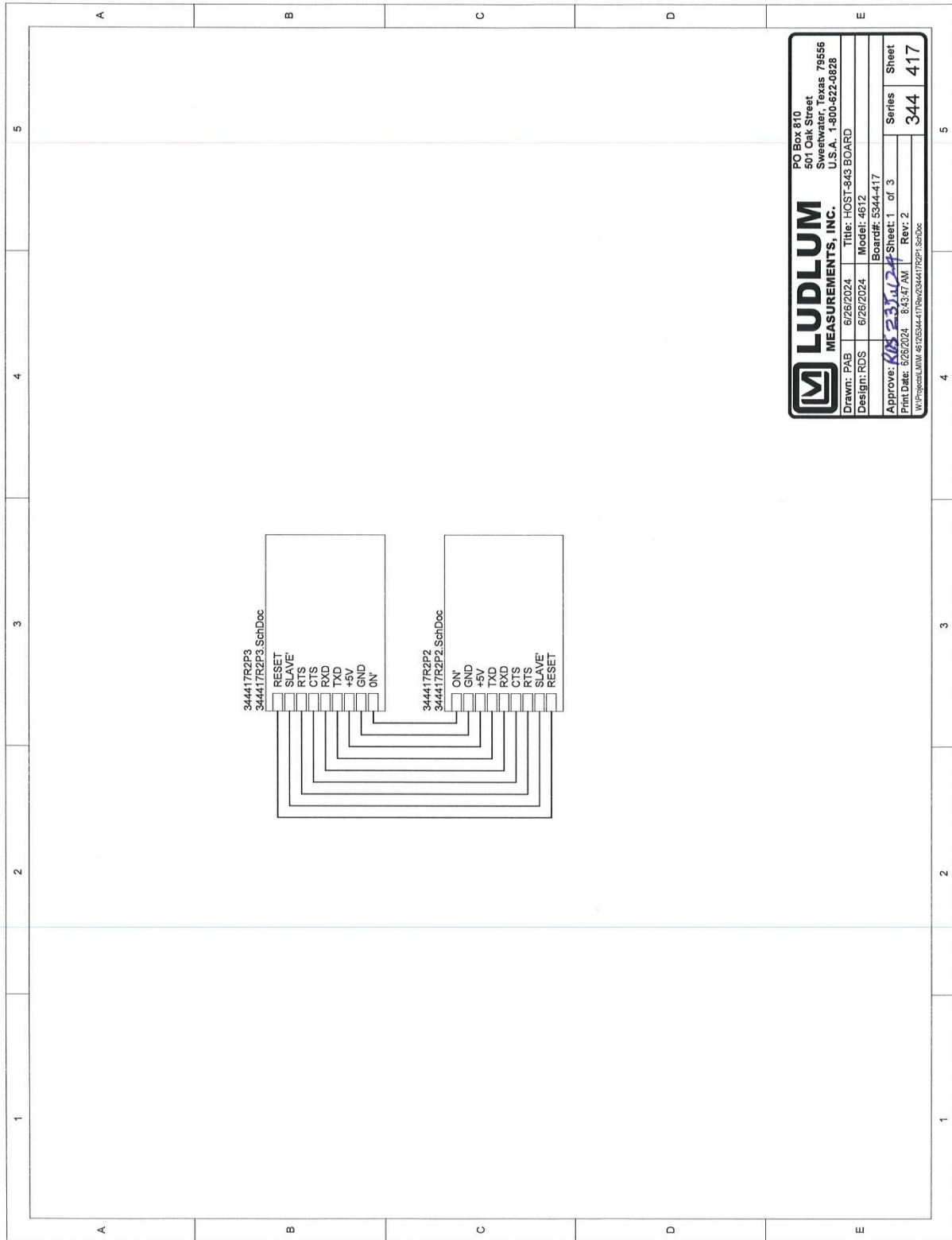

LUDLUM
MEASUREMENTS, INC.

PO Box 810
501 Oak Street
Sweetwater, Texas 79556
U.S.A. 1-800-622-0628

Drawn: PAB	6/26/2024	Title: HOST-843 BOARD	Model#: 4612
Design: RDS	6/26/2024	Board#: 5344-417	Sheet: 1 of 3
Approve: <i>KR</i>	6/26/2024	8:43:47 AM	Rev: 2
W:\P38\LU\4612\5344-17R2P3\2417R2P3.SchDoc			Series 344
			Sheet 417

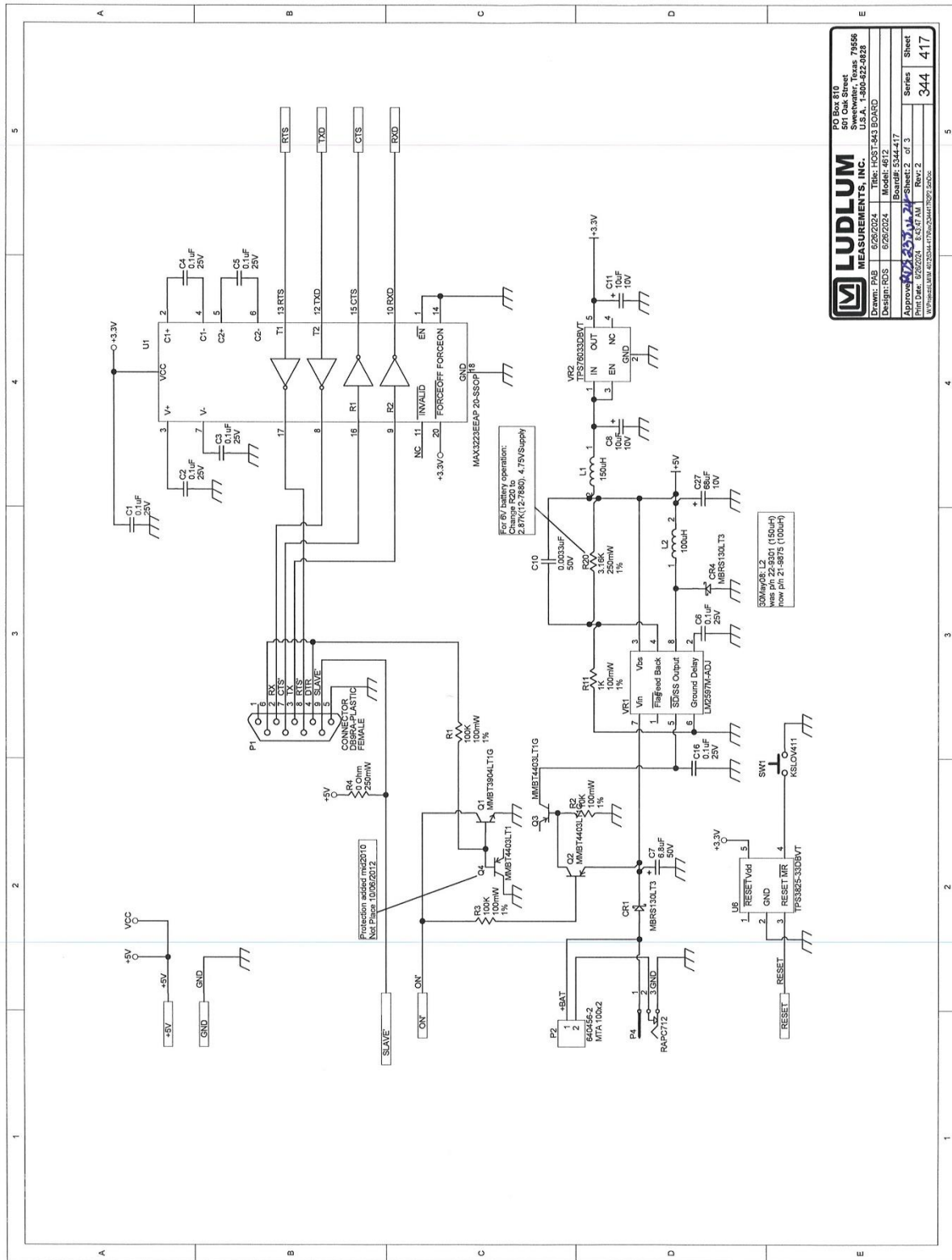

LUDLUM	
MEASUREMENTS, INC.	
507 Oak Street Sweetwater, Texas 79556 U.S.A. T-800-422-3828	
Customer: 438	0/28/2024
Designer: RDC	8/26/2024
Model: 4612	Board#: 5344-417
Approval: <i>[Signature]</i>	Sheet: 2 of 3
Print Date: 07/25/2024	8:53:47 AM
Rev: 2	Series: 344
	Sheet: 417

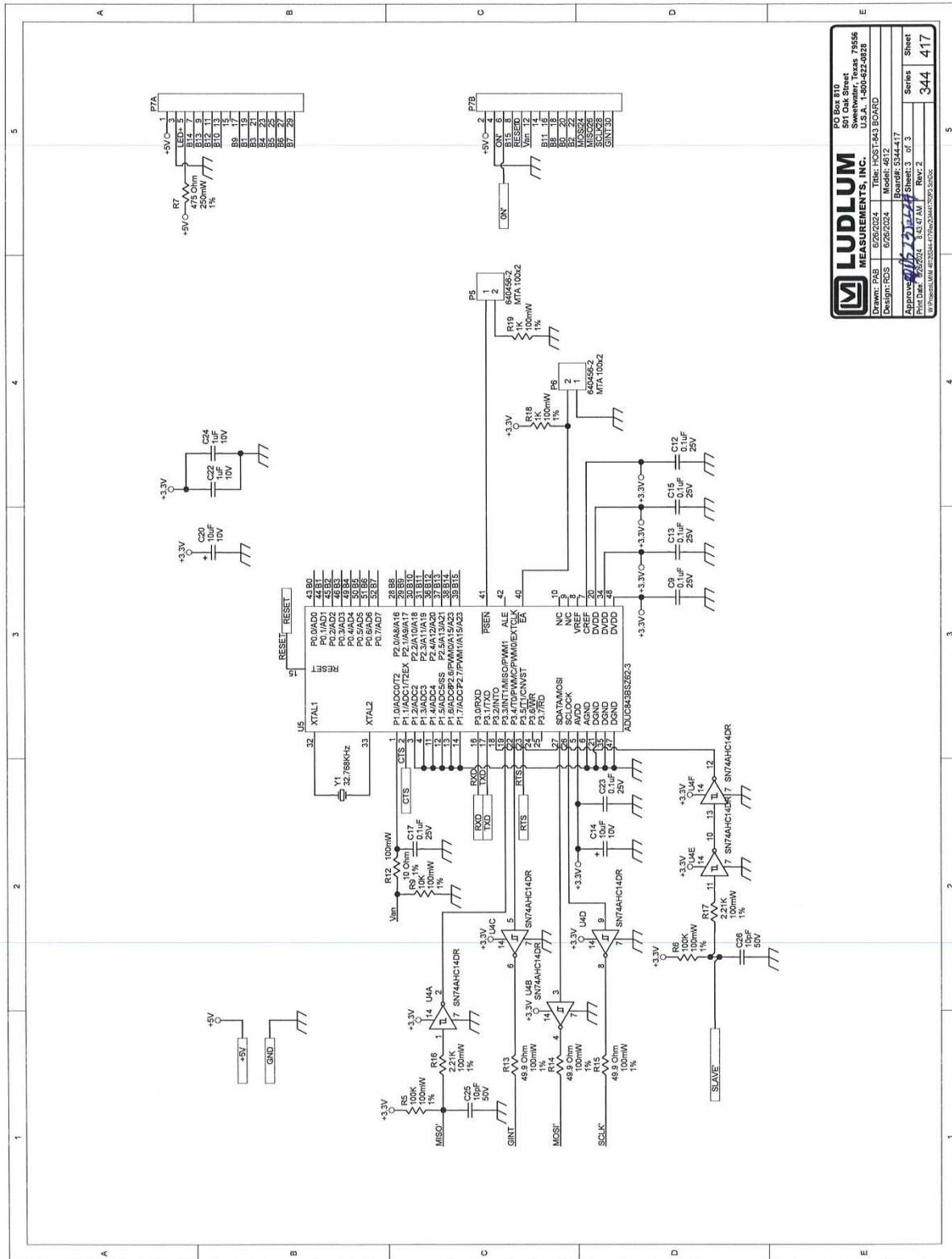

LUDLUM MEASUREMENTS, INC.
 P.O. Box 417
 801 Oak Street
 Sweetwater, Texas 75556
 U.S.A. 1-800-822-0828

Design: P43 0262024
 Design: PCB 0262024
 Title: P43 043 BOARD
 Board#: 344417
 Sheet: 3 of 3
 Series: 344 417
 Approved: [Signature]
 Print Date: 8/25/04 8:53:77 AM
 Rev: 2
 P:\Projects\BOM 4073304\47762\34417\93\5050

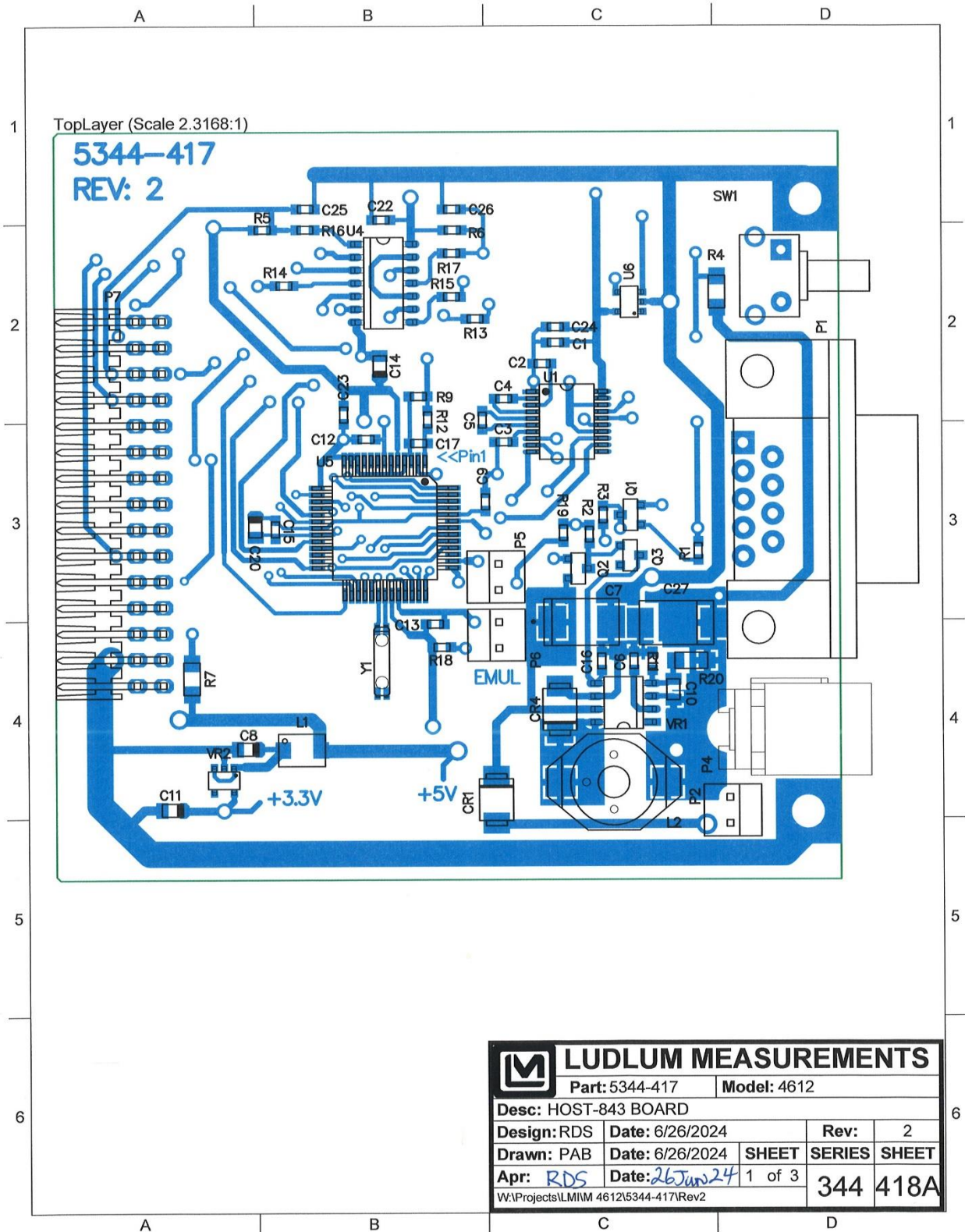

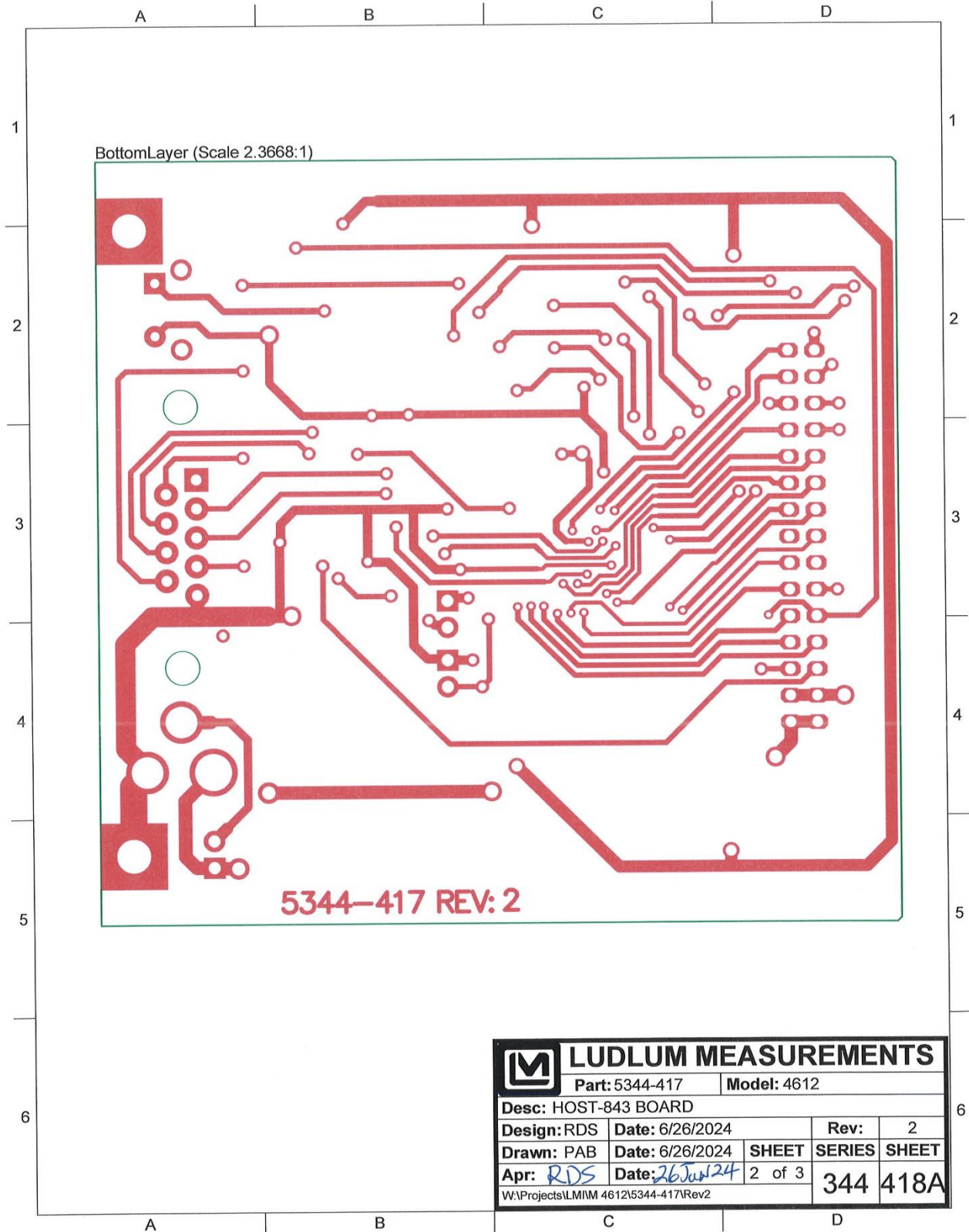

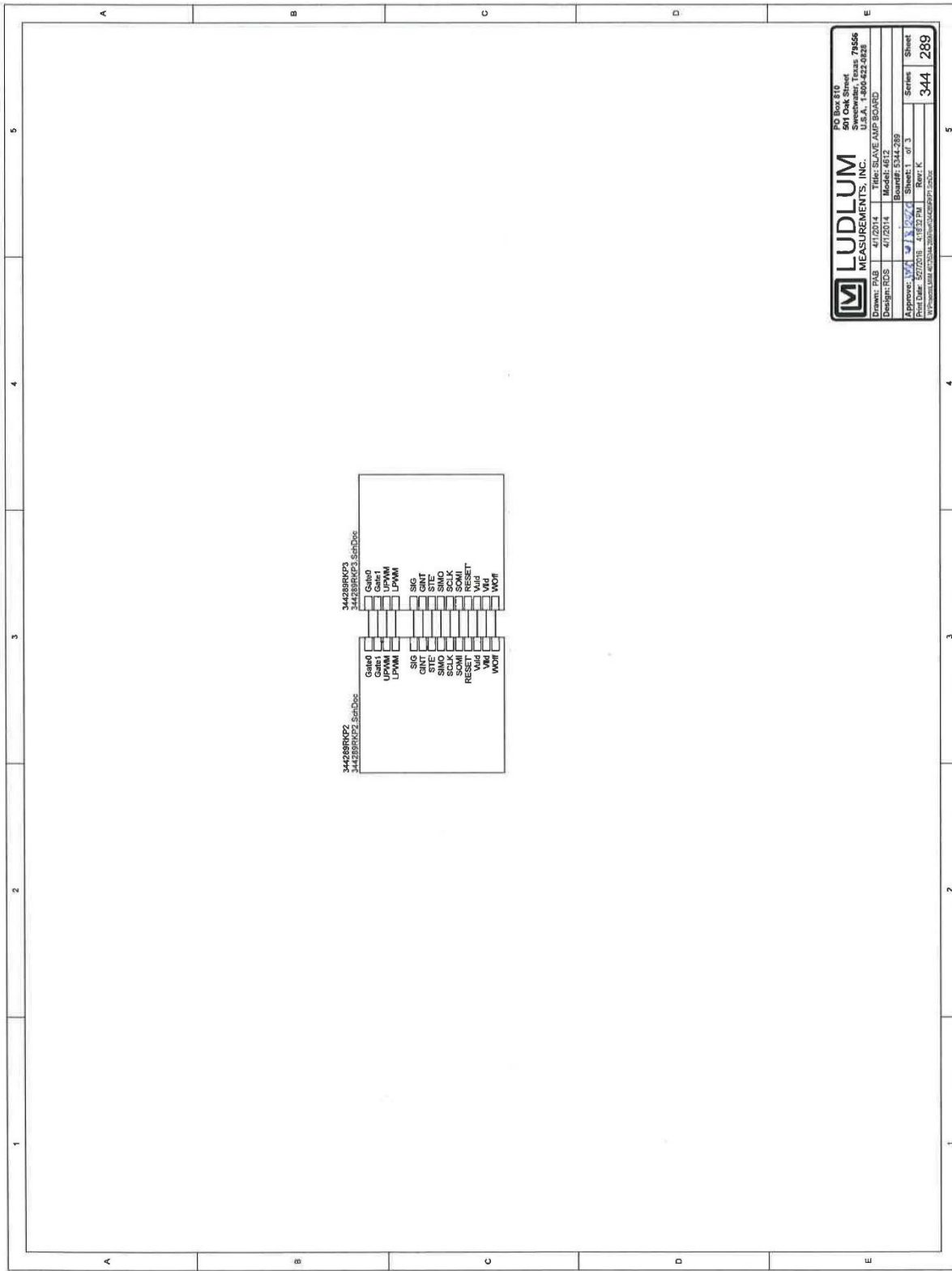

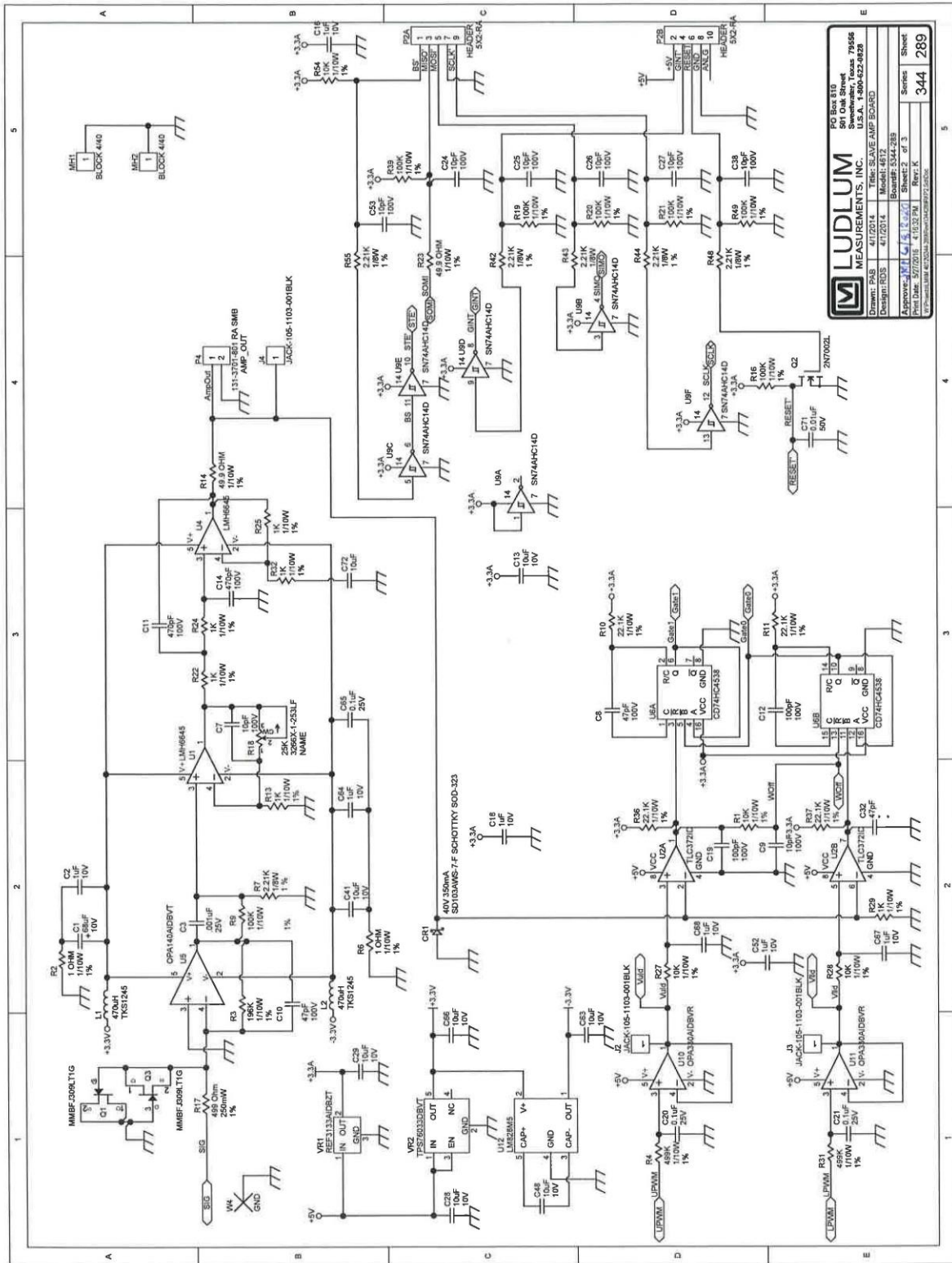

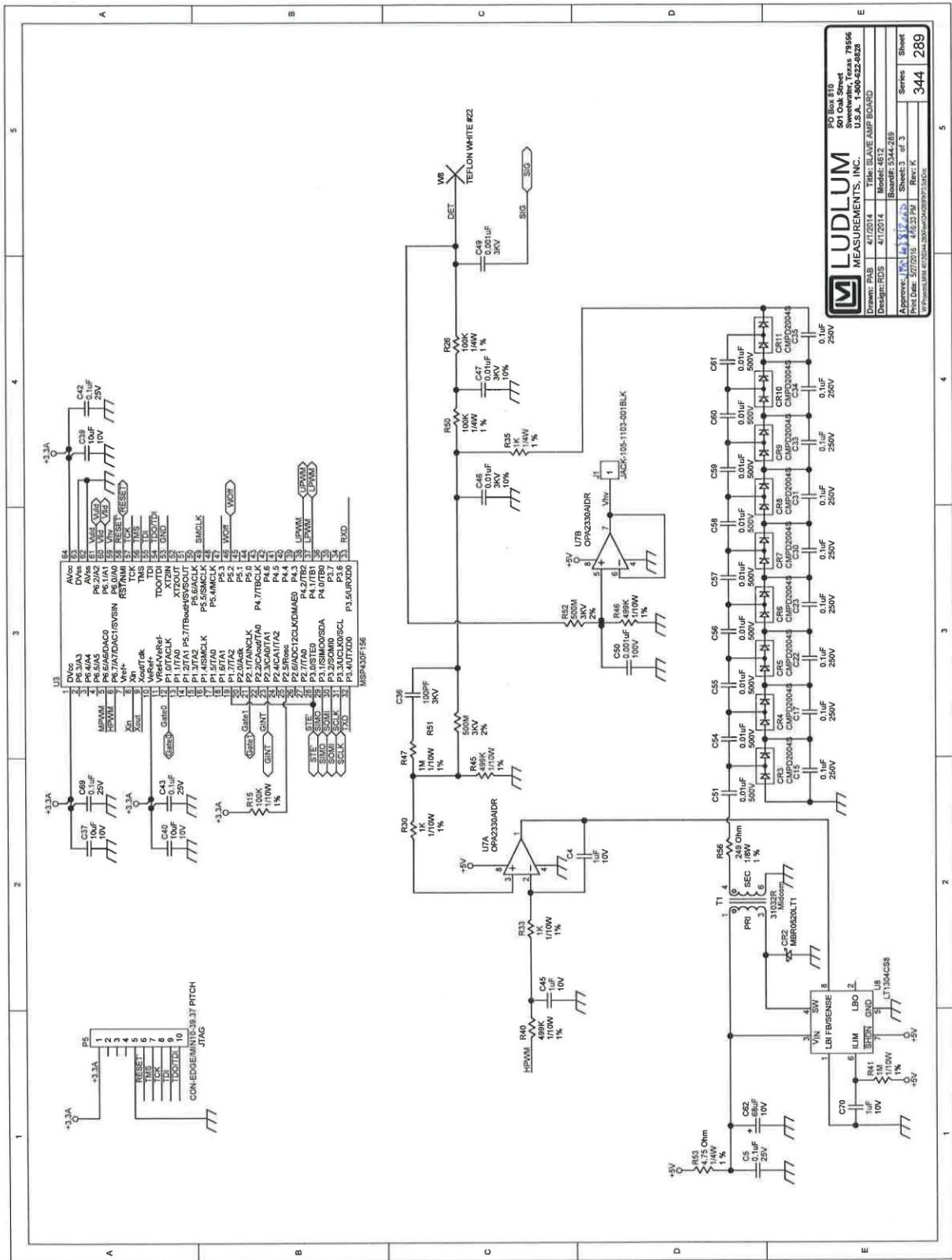

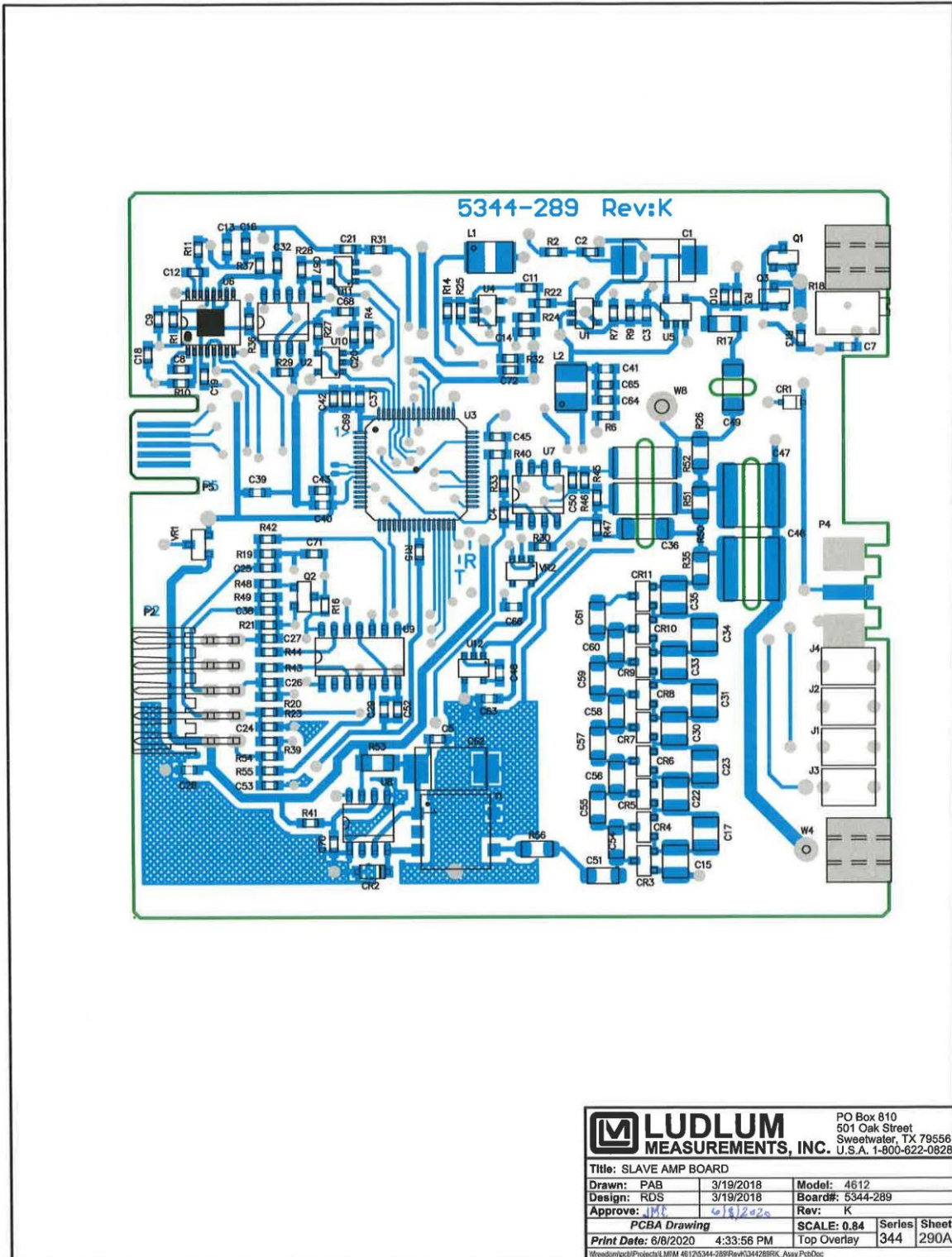

LUDLUM	
MEASUREMENTS, INC.	
Drawn: PAE	4/17/2014
Design: RDS	4/17/2014
Approved: [Signature]	4/23/2014
Print Date: 5/7/2015	4:42:33 PM
Part: 4404-16	Rev: K
Model: 4572	Sheet: 3 of 3
Series	344
Sheet	289

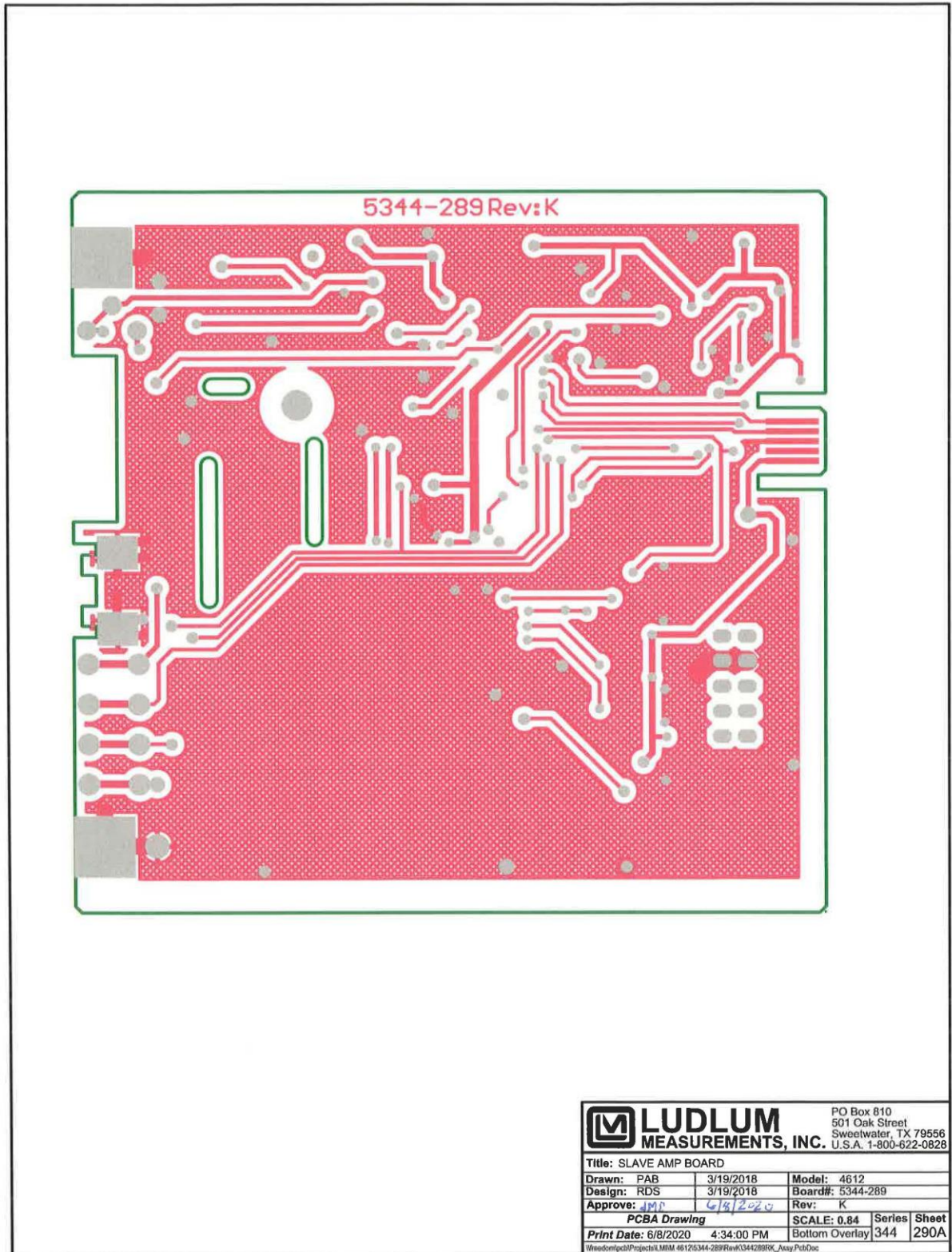

		PO Box 810 501 Oak Street Sweetwater, TX 79556 U.S.A. 1-800-622-0828	
		Title: SLAVE AMP BOARD	
Drawn: PAB	3/19/2018	Model: 4612	
Design: RDS	3/19/2018	Board#: 5344-289	
Approve: JMT	6/8/2020	Rev: K	
PCBA Drawing		SCALE: 0.84	Series 344 Sheet 290A
Print Date: 6/8/2020	4:33:56 PM	Top Overlay	
<small>\\freedom\pdr\Projects\LMMIM 4612\5344-289\Fw\K344289R\K Assy Pcb.Doc</small>			

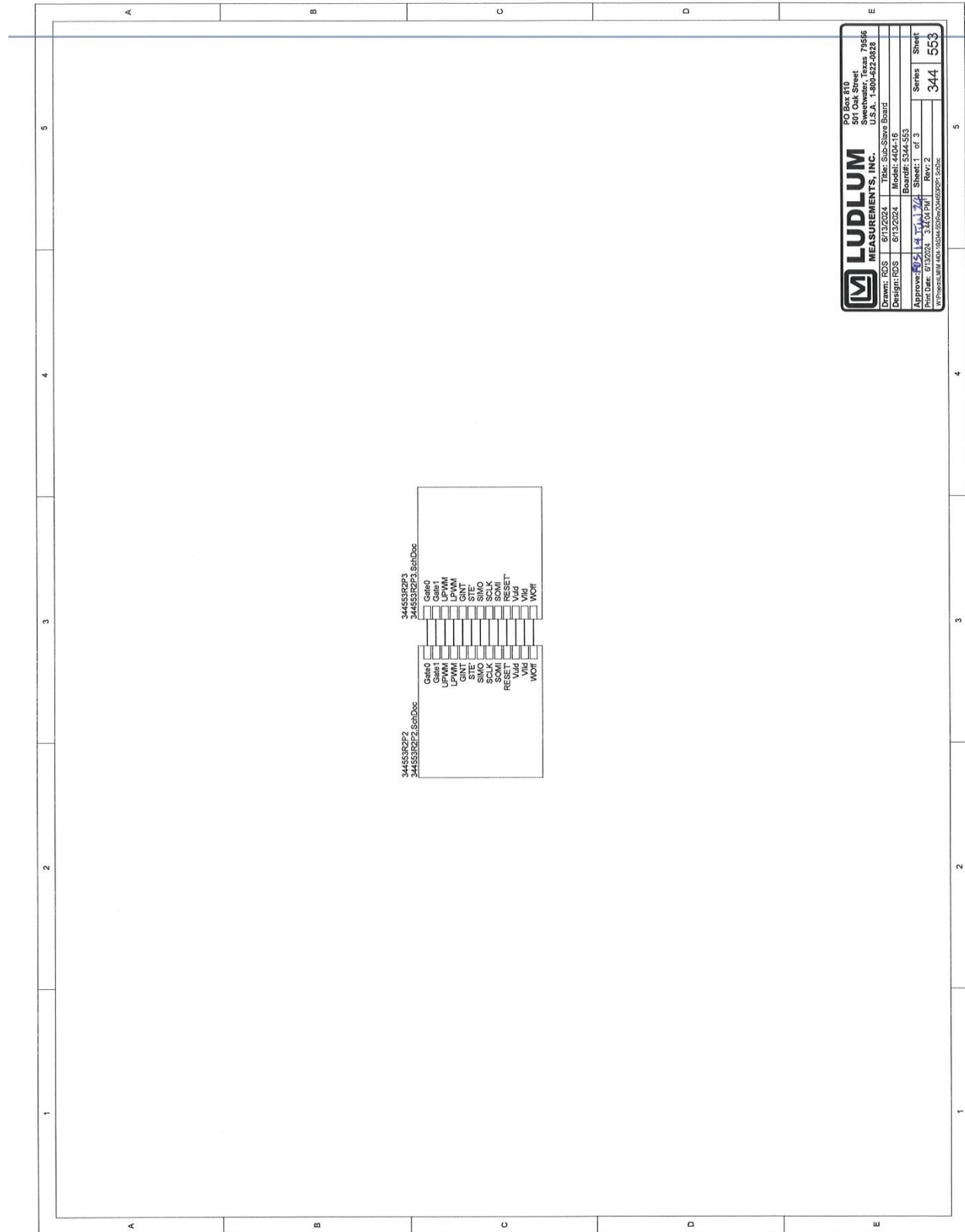





LUDLUM MEASUREMENTS, INC.
 PO Box 810
 501 Oak Street
 Newburgh, NY 12550
 U.S.A. 518-489-4224/4232

Drawn: RDS	6/13/2024	Title: Sub-Slurry Board	Model: 4404-16	Board#: 5344-553
Design: RDS	6/13/2024			
Approved: <u>WJL</u>	<u>7/1/24</u>	Sheet: 1 of 3	Series: <u>344</u>	Sheet: <u>553</u>
Print Date: 6/13/2024	3:24 PM	Rev: 2		

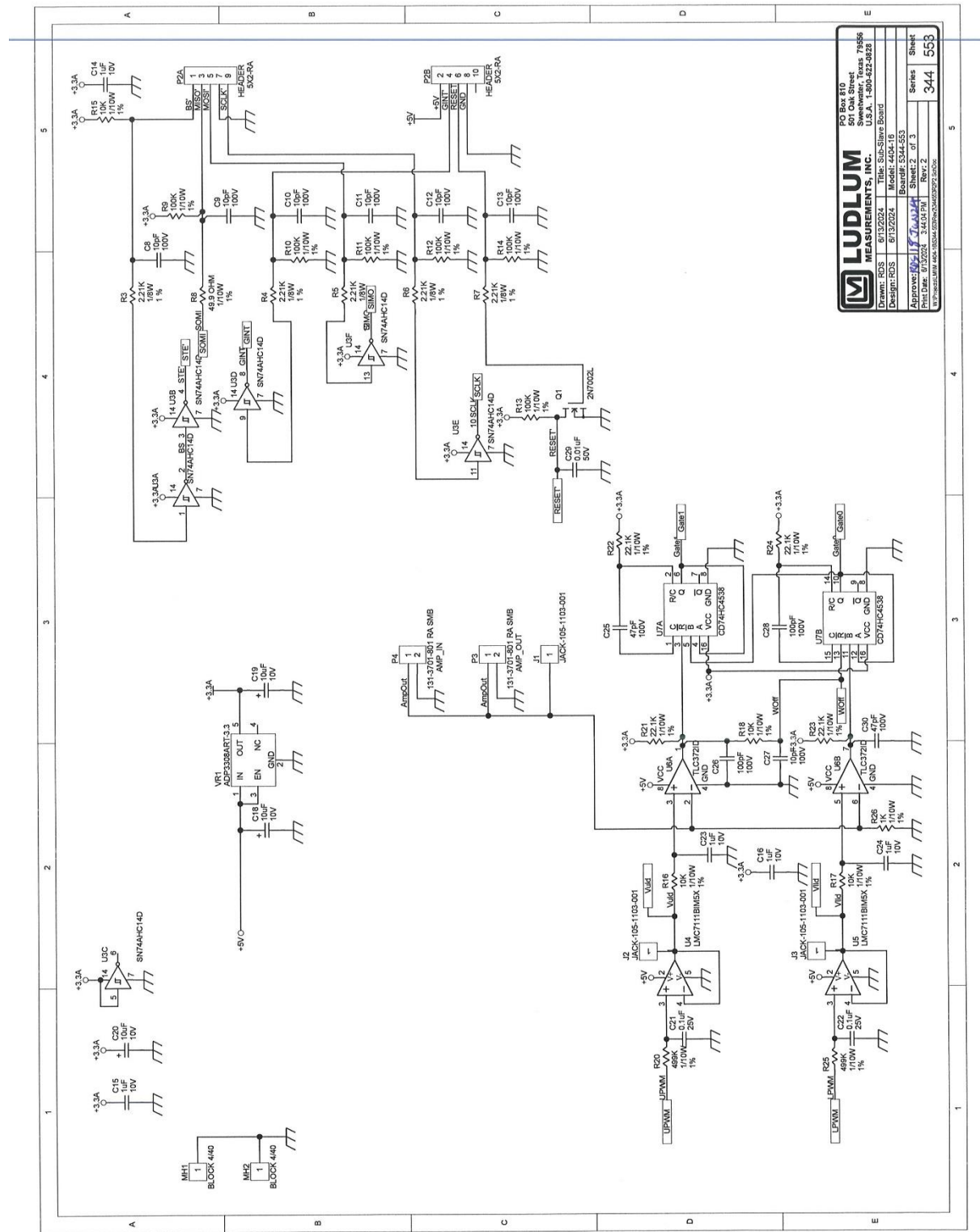
P:\Projects\4404-16\344532P2\344532P2.dwg
 P:\Projects\4404-16\344532P2\344532P2.plt

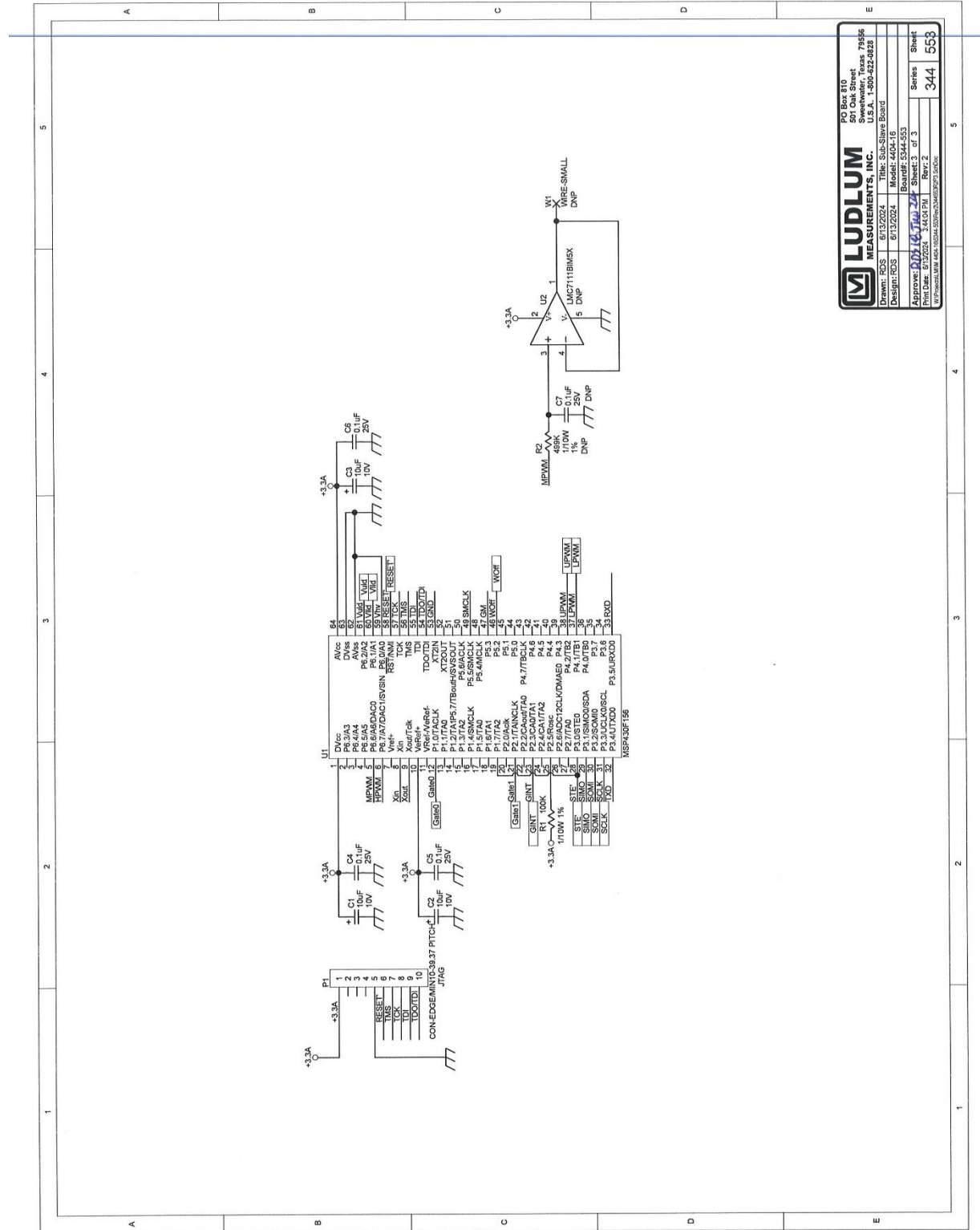



LUDLUM MEASUREMENTS, INC.
 805 Box 810
 201 Oak Street
 Sweetwater, Texas 79556
 U.S.A. 1-800-822-8828

Drawn: RCS
 Design: RCS
 Date: 6/13/2024
 Title: Geo-Exploration Board

Approved: *[Signature]*
 Date: 6/13/2024
 Title: Senior Board

Board#: 5344-553
 Sheet: 3 of 3
 Series: 344
 Rev: 2
 Sheet: 558

© 2024 Ludlum Measurements, Inc. All rights reserved.

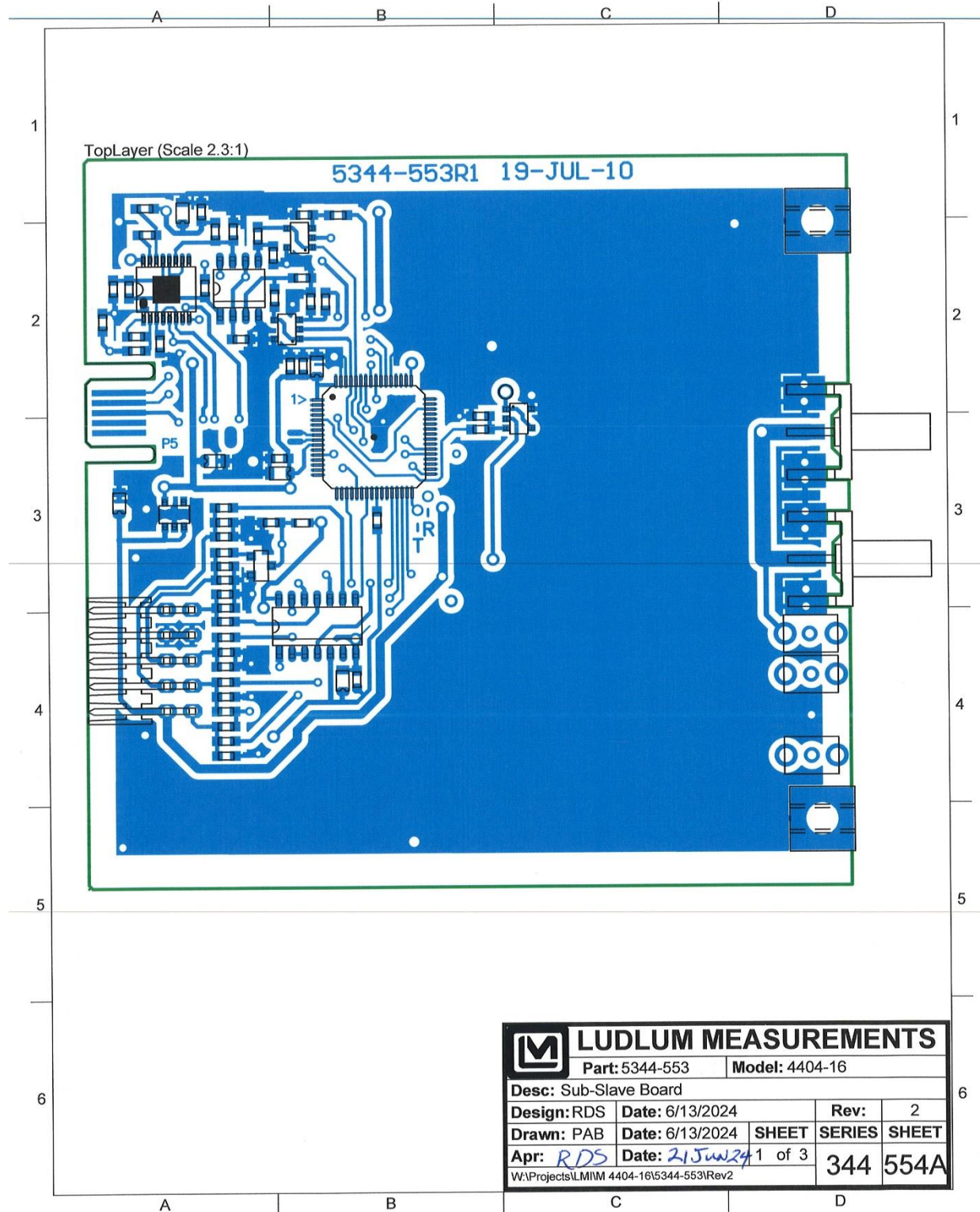

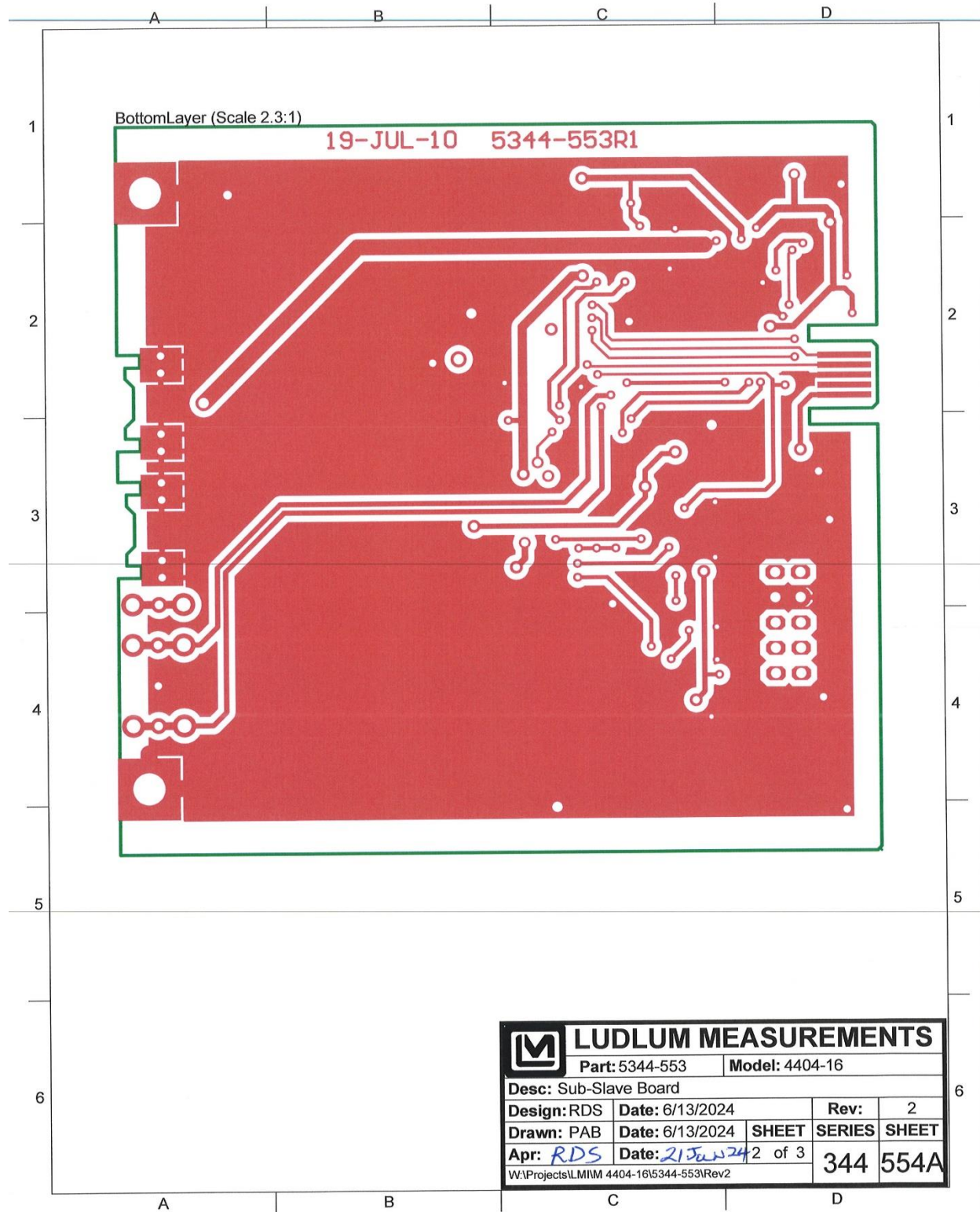

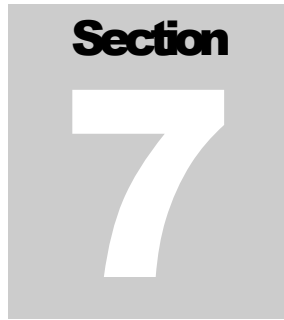
A graphic consisting of a grey square with the word "Section" in bold black text at the top and a large white number "7" in the center.

Hardware Calibration

A Ludlum Model 500 Pulser or equivalent is required. If the pulser does not have a high-voltage readout, use a high impedance voltmeter with at least 1000 megohm input resistance to measure the detector voltage.

1. Remove the cover of the Model 4404-16.
2. Connect the Model 500 Pulser to the Model 4404-16 Channel #1 using an appropriate cable.
3. Adjust the pulser for 40,000 cpm and set the pulse amplitude to -10 mV (negative amplitude).
4. Start the Counter.exe program and “connect” to the Model 4404-16.
5. Observe the Model 500 HV readout (or connect the high impedance meter). Using your PC and the Model 4404-16 Counter software, set the HV control to 900 Vdc. Check for an actual high voltage reading of 900 V \pm 4 volts and adjust if necessary the potentiometer on top of the slave board (#1) and closest to front panel for a reading of 900 Vdc on the voltmeter or pulser. Connect the voltmeter between the HVR test point (+) on the rear panel of Slave #1 and ground (the screw head (-) located just to the right of the LMI logo on the panel). Adjust the HVR pot located closest to the rear panel for a meter reading of 0.900 Vdc \pm 0.004 Vdc.
6. Set the HV to 500 and finally to 1200 Vdc and confirm that the reading of the HV meter corresponds to the external voltmeter within \pm 5% of each reading.
7. Set the LLD for all channels to 100 and set the ULD to 200.
Note: this results in a calibration level of 10 mV threshold and 10 mV window.

8. Connect the voltmeter between the LLD test point (+) on the rear panel of Slave #1 and ground (-) (the screw head located just to the right of the LMI logo on the panel). Check that the voltage here is 100 mVdc $\pm 5\%$.
9. Connect the voltmeter between the ULD test point (+) on the rear panel of Slave #1 and ground (-) (the screw head located just to the right of the LMI logo on the panel). Check that the voltage is 200 mVdc $\pm 5\%$.
10. Observe the count rate for Channel #1. With an output time of 0.50 seconds, the count rate should show a value of 100. Adjust the gain control (GN) clockwise (located on the rear panel of the slave board) to obtain the 100 reading, then adjust the control counter-clockwise to the point where the counts just cease (less than 10 counts observed).
11. With the LLD = 100 and ULD = 200 for all channels, observe the count rate for Channel #1. With an output time of 0.50 seconds, the count rate should show a value of 100 with the pulser amplitude set to -15mV. Adjust the pulser amplitude toward -20 mV and confirm that the reading drops to 0 (less than 10 counts) at -20 mV ± 0.5 mV.
12. Repeat steps 7 thru 10 above for all remaining channels.

Section**8**

RS-232 Communication

The Model 4404-16 Counter operates at the following RS-232 parameters:

- 19200 Baud
- 8 Data bits
- No Parity
- 1 Stop bit

To retrieve count data, the dump command must be issued. This is done by sending an uppercase “D” followed by a carriage return and line feed. The message returned contains the count data for each channel and the status of each channel. The message is terminated with a carriage return and line feed character. The count data is the number of counts received in the previous one second.

Byte 01 – Channel 01
Byte 02 – Channel 01
Byte 03 – Channel 01
Byte 04 – Channel 02
Byte 05 – Channel 02
Byte 06 – Channel 02
Byte 07 – Channel 03
Byte 08 – Channel 03
Byte 09 – Channel 03
Byte 10 – Channel 04
Byte 11 – Channel 04
Byte 12 – Channel 04
Byte 13 – Channel 05
Byte 14 – Channel 05
Byte 15 – Channel 05
Byte 16 – Channel 06
Byte 17 – Channel 06

Byte 18 – Channel 06
Byte 19 – Channel 07
Byte 20 – Channel 07
Byte 21 – Channel 07
Byte 22 – Channel 08
Byte 23 – Channel 08
Byte 24 – Channel 08
Byte 25 – Channel 09
Byte 26 – Channel 09
Byte 27 – Channel 09
Byte 28 – Channel 10
Byte 29 – Channel 10
Byte 30 – Channel 10
Byte 31 – Channel 11
Byte 32 – Channel 11
Byte 33 – Channel 11
Byte 34 – Channel 12
Byte 35 – Channel 12
Byte 36 – Channel 12
Byte 37 – Channel 01 Status
Byte 38 – Channel 02 Status
Byte 39 – Channel 03 Status
Byte 40 – Channel 04 Status
Byte 41 – Channel 05 Status
Byte 42 – Channel 06 Status
Byte 43 – Channel 07 Status
Byte 44 – Channel 08 Status
Byte 45 – Channel 09 Status
Byte 46 – Channel 10 Status
Byte 47 – Channel 11 Status
Byte 48 – Channel 12 Status
Byte 49 – Carriage Return (\r)
Byte 50 – Line Feed (\n)

The count for each channel is stored in three bytes. To convert the bytes into the count, multiply each byte as follows:

$$(\text{Byte 1} * 65536) + (\text{Byte 2} * 256) + \text{Byte 3}$$

The Status byte is configured as:

Bit 0: Slave counting status (0 = counting, 1 = not counting).

Bit 1: Overload status. Currently not used.

Bit 2: HV out of tolerance by 3% (0 = OK, 1 = OOT).

Bit 3: LLD out of tolerance by 13% (0 = OK, 1 = OOT).

Bit 4: ULD out of tolerance by 3% (0 = OK, 1 = OOT).

Bit 5: Not used.

Bit 6: Not used.

Bit 7: Slave online/offline status (0 = offline, 1 = online).

RS-232 Commands

All commands must be in upper case letters and terminated with a line feed (/n) character. Channels are designated as 0, 1, 2, 3 4, 5, 6, 7, 8, 9, A, and B, which correspond to channels 1–12. When sending commands to set and read parameters, the data output must be stopped using the “SO” command.

Read Count - D

Reads the count. The software issues this command every time an RMC GPS message is received.

Read Firmware Version - F

Reads the firmware version of the host board.

Read GM Mode - RGn

Reads the GM mode of the specified channel. A “1” is returned if the GM mode is enabled, “0” if disabled.

Set GM Mode - SGnx

Sets the GM mode of the specified channel. A “1” enables the GM mode, “0” disables the GM mode.

Read Window Mode - RWh

Reads the Window mode of the specified channel. A “1” is returned if the Window mode is enabled, “0” if disabled.

Set Window Mode - SWrx

Sets the Window mode of the specified channel. A “1” enables the Window mode, “0” disables the Window mode.

Read Efficiency – RE_n

Reads the efficiency of the specified channel. The value returned is formatted as “nn.n”.

Set Efficiency – SE_{no}

Sets the efficiency for the specified channel. The efficiency is set using the format of “nnn.” Do not send the decimal point. The value must be formatted to three digits and is adjustable from 000 to 999.

Save Slave Flash Parameters – SF

Saves all calibration constants to flash on all slave boards. The calibration constants will revert to the last saved values if the counter is reset without saving.

Read High Voltage – RH_n

Reads the high voltage setpoint and readback value from the specified channel. The return format is “HVnnnnnnnn.” The first four characters are the setpoint; the last four characters are the readback voltage.

Set High Voltage – SH_{no}

Sets the high voltage setpoint for the specified channel. The value must be formatted to four digits and is adjustable from 0000 to 1500.

Read High Voltage Actual Cal – RHAC_n

Reads the high voltage, actual calibration constant for the specified channel. The return format is “±n.n.”

Set High Voltage Actual Cal – SHAC_{no}

Sets the high voltage, actual calibration constant for the specified channel. The value must be formatted as “±nn.” Do not include the decimal place. The range is -99 to +99. After setting any calibration constant, the “SF” command must be sent to save the values into flash.

Read High Voltage Readback Cal – RHRC_n

Reads the high voltage readback calibration constant for the specified channel. The return format is “±n.n.”

Set High Voltage Readback Cal – SHRC_{no}

Sets the high voltage readback calibration constant for the specified channel. The value must be formatted as “±nn.” Do not include the decimal place.

The range is -99 to +99. After setting any calibration constant, the “SF” command must be sent to save the values into flash.

Read LLD – RLn

Reads the lower level discriminator setpoint and readback value from the specified channel. The return format is “LDnnnnnnnn.” The first four characters are the setpoint; the last four characters are the readback voltage.

Set LLD – SLnxxxx

Sets the lower level discriminator setpoint for the specified channel. The value must be formatted to four digits and is adjustable from 0000 to 3300.

Read LLD Actual Cal - RLCnxxxx

Reads the lower level discriminator actual calibration constant for the specified channel. The return format is “±n.n.”

Set LLD Actual Cal – SLCnxxxx

Sets the lower level discriminator actual calibration constant for the specified channel. The value must be formatted as “±nn.” Do not include the decimal place. The range is -99 to +99. After setting any calibration constant, the “SF” command must be sent to save the values into flash.

Read ULD – RUn

Reads the upper level discriminator setpoint and readback value from the specified channel. The return format is “UDnnnnnnnn.” The first four characters are the setpoint; the last four characters are the readback voltage.

Set ULD – SUnxxxx

Sets the upper level discriminator setpoint for the specified channel. The value must be formatted to four digits and is adjustable from 0000 to 3300.

Read ULD Actual Cal – RUCnxxxx

Reads the upper level discriminator, actual calibration constant for the specified channel. The return format is “±n.n.”

Set ULD Actual Cal – SUCnxxxx

Sets the upper level discriminator, actual calibration constant for the specified channel. The value must be formatted as “±nn.” Do not include the decimal place. The range is -99 to +99. After setting any calibration constant, the “SF” command must be sent to save the values into flash.