

**LUDLUM MODEL 44-142
BETA SCINTILLATOR**

June 2024

**LUDLUM MODEL 44-142
BETA SCINTILLATOR**

June 2024



LUDLUM MEASUREMENTS, INC
501 OAK STREET, P.O. BOX 810
SWEETWATER, TEXAS 79556
325-235-5494, FAX: 325-235-4672

STATEMENT OF WARRANTY

Ludlum Measurements, Inc. warrants the products covered in this manual to be free of defects due to workmanship, material, and design for a period of twelve months from the date of delivery. The calibration of a product is warranted to be within its specified accuracy limits at the time of shipment. In the event of instrument failure, notify Ludlum Measurements to determine if repair, recalibration, or replacement is required.

This warranty excludes the replacement of photomultiplier tubes, G-M and proportional tubes, and scintillation crystals which are broken due to excessive physical abuse or used for purposes other than intended.

There are no warranties, express or implied, including without limitation any implied warranty of merchantability or fitness, which extend beyond the description of the face there of. If the product does not perform as warranted herein, purchaser's sole remedy shall be repair or replacement, at the option of Ludlum Measurements. In no event will Ludlum Measurements be liable for damages, lost revenue, lost wages, or any other incidental or consequential damages, arising from the purchase, use, or inability to use product.

RETURN OF GOODS TO MANUFACTURER

If equipment needs to be returned to Ludlum Measurements, Inc. for repair or calibration, please send to the address below. All shipments should include documentation containing return shipping address, customer name, telephone number, description of service requested, and all other necessary information. Your cooperation will expedite the return of your equipment.

**LUDLUM MEASUREMENTS, INC.
ATTN: REPAIR DEPARTMENT
501 OAK STREET
SWEETWATER, TX 79556**

**800-622-0828 325-235-5494
FAX 325-235-4672**

Table of Contents

<i>Introduction</i>	<i>1</i>
<i>Specifications</i>	<i>2</i>
<i>Safety Considerations</i>	<i>3</i>
Environmental Conditions for Normal Use	3-1
Cleaning Instructions and Precautions	3-1
Repair and Calibration	3-1
<i>Parts List</i>	<i>4</i>
Assembly View, Drawing 393 × 140	4-1
1 1/8 inch Voltage Divider, Drawing 435 × 1325	4-1
<i>Drawings and Diagrams</i>	<i>5</i>

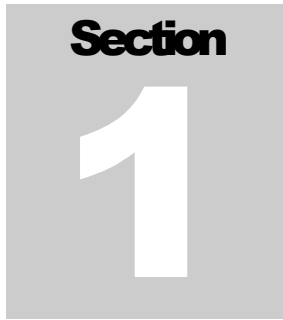
A gray square graphic with the word "Section" in bold black text at the top and a large white number "1" in the center.

Introduction

The Model 44-142 detector contains a 0.25 cm (0.010 in.) thick plastic scintillator for the detection of beta radiation. The scintillator is rectangular in shape, with an active area of 100 cm². The window is covered by 1.2 mg/cm² metalized polyester to reduce light response. (Light response can cause excessive background counts.)

A stainless steel screen protects the window. The external, snap-on screen has square openings (88% open). The photomultiplier tube/socket assembly may easily be removed for replacement (refer to the assembly view drawing near the end of this manual for detail of construction and parts). The photomultiplier tube (PMT) typically operates between 700-1200 volts and the manufacturer recommends no more than 1500 volts. General purpose survey meters, ratemeters, or scalers are compatible with this detector.

Section

2

Specifications

Photomultiplier Tube: 2.9 cm (1.125 in.) diameter; magnetically shielded

Scintillator Material: 0.25 mm (0.01 in.) thick rectangular plastic scintillator

Window: 1.2 mg/cm² metalized polyester

Window Area:

Active area: approximately 100 cm²

Open area: approximately 88 cm²

Efficiency (4 π): typically 20% for ⁹⁹Tc, 30% for ⁹⁰Sr/⁹⁰Y, and 4% for ¹⁴C

Typical Background: 300 cpm or less in a 10 μ R/hr field

Detector Uniformity: within 10% of average reading for ⁹⁹Tc

Operating Voltage: typically 500-1200 Vdc (1500 Vdc max.)

Dynode String Resistance: 60 megohm

Gamma Sensitivity: approximately 20 cpm/ μ R/hr (¹³⁷Cs)

Dead Time: typically 5 μ sec or less

Temperature Range: -20 to 50 °C (-4 to 122 °F)

Connector: Series “C” (others available)

Protective Screen: snap-on, 0.76 mm (0.03 in.) thick stainless steel with 6.5 mm (0.26 in.) square-holes, 88% open

Size: 6.4 x 9.5 x 31.1 cm (2.5 x 3.8 x 12.3 in.) (H x W x L)

Weight: 0.5 kg (1 lb)

Construction: aluminum housing with beige powder-coat finish

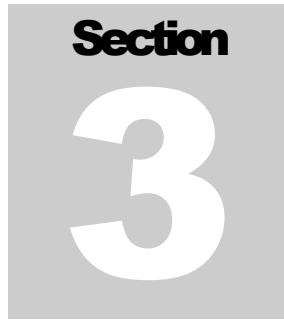
A gray square graphic containing the word "Section" in a bold, black, sans-serif font at the top, and a large, white, bold, sans-serif number "3" in the center.

Safety Considerations

Environmental Conditions for Normal Use

Indoor or outdoor use

No maximum altitude

Temperature range of -20 to 50 °C (-4 to 122 °F)

Maximum relative humidity of less than 95% (non-condensing)

Cleaning Instructions and Precautions

The detectors specified in this manual may be cleaned externally with a damp cloth, using only water as the wetting agent. Do not immerse the detector in any liquid. Do not attempt to clean a detector that is attached to an instrument providing high voltage. Disconnect the detector cable before cleaning.

Repair and Calibration

To return an instrument for repair or calibration, provide sufficient packing material to prevent damage during shipment.

Every returned instrument must be accompanied by an Instrument Return Form, which can be downloaded from the Ludlum website at www.ludlums.com. Find the form by clicking the “Support” tab and selecting “Service Center” from the drop-down menu. Then choose the appropriate Service Center division where you will find a link to the form.

Section 4

Parts List

	<u>Reference</u>	<u>Description</u>	<u>Part Number</u>
Assembly View, Drawing 393 × 140	UNIT	Model 44-142 Beta Scintillator	47-3161
	1 each	Body with Tube Ring	2393-141
	1 each	Mylar Window Assembly	4393-149
	1 each	1.125 inch Photomultiplier Tube	01-6005
	1 each	1 1/8 inch 9 Stage Voltage Divider	5435-484
	1 each	FOIL NETIC ASO PLAIN	01-5019
	1 each	FOIL CO-NETIC AAA	01-5026
	1 each	RECPT-UG706/U "C" LMI	4478-011
	1 each	O RING-2-120	16-8366
	1 each	Mirror	2310698
	1 each	Tube Holder Assembly	2393-117
	1 each	Scintillator EJ212	01-5674
	1 each	Scintillator Backup	7393-150
	1 each	Gasket	7393-139
	6 each	Sponge	7002-065-04
	1 each	Screen	7393-171
	1 each	Vinyl Screen Cover	7393-162
1 1/8 inch Voltage Divider Board, Drawing 435 × 1325	BOARD	Completely Assembled 1 1/8 inch Voltage Divider Board	5435-484
CAPACITORS	C1- C3	0.01uF, 200V	04-5725
	C4	0.0047uF, 3KV	04-5547
RESISTORS	R1	10M, 1/8W, 1%	12-7996
	R2	7.5M, 1/8W, 5%	12-7971
	R3-R10	10M, 1/8W, 1%	12-7996
	R11	2.21M, 1/8W, 1%	12-7002
	R12-R13	10M, 1/8W, 1%	12-7996
	MISCELLANEOUS	*	SOCKET 1 1/8" PCB MOUNT
W1		#22AWG WHT 9 65/40	21-8543
W4		#22 AWG BLK 0 65/40	21-8552

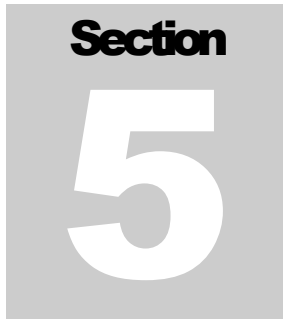
A gray square graphic containing the word "Section" in a bold, black, sans-serif font at the top, and a large, white, bold, sans-serif number "5" in the center.

Drawings and Diagrams

Assembly View, Drawing 393 × 140

1 1/8 inch Voltage Divider Circuit Board, Drawing 435 × 1325

1 1/8 inch Voltage Divider Component Layout, Drawing 435 × 1324
(2 sheets)

REVISION HISTORY			
REV	DESCRIPTION	DATE	BY
5	UPDATED TOLERANCES	7-22-21	CMC
6	UPDATED	7-11-23	JGW

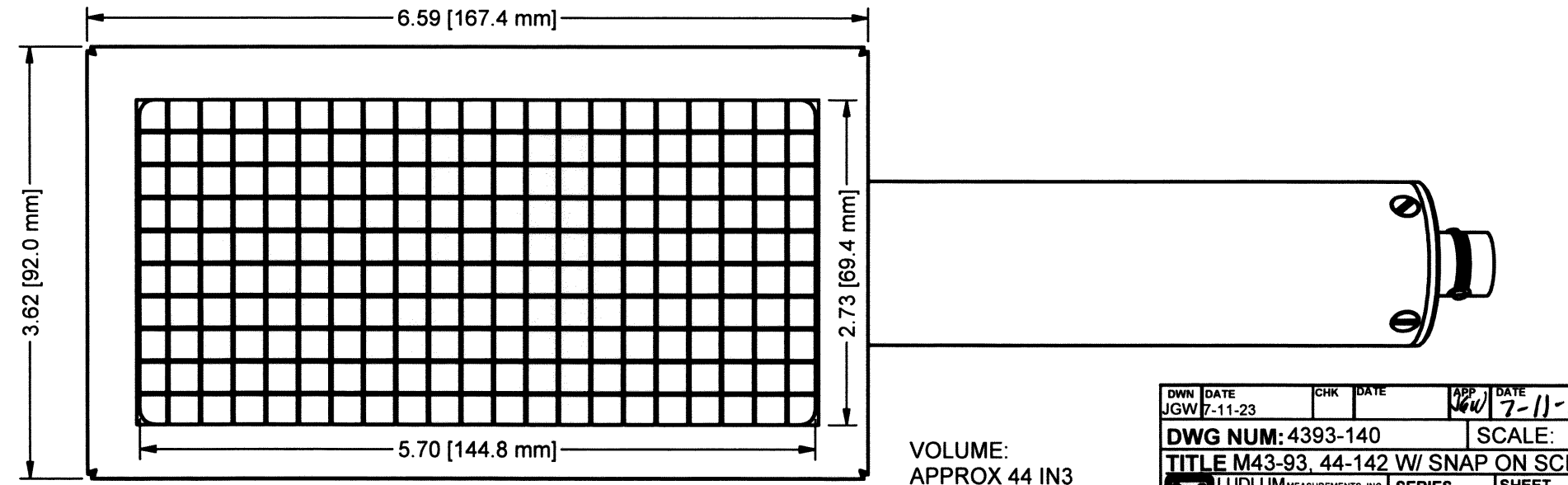
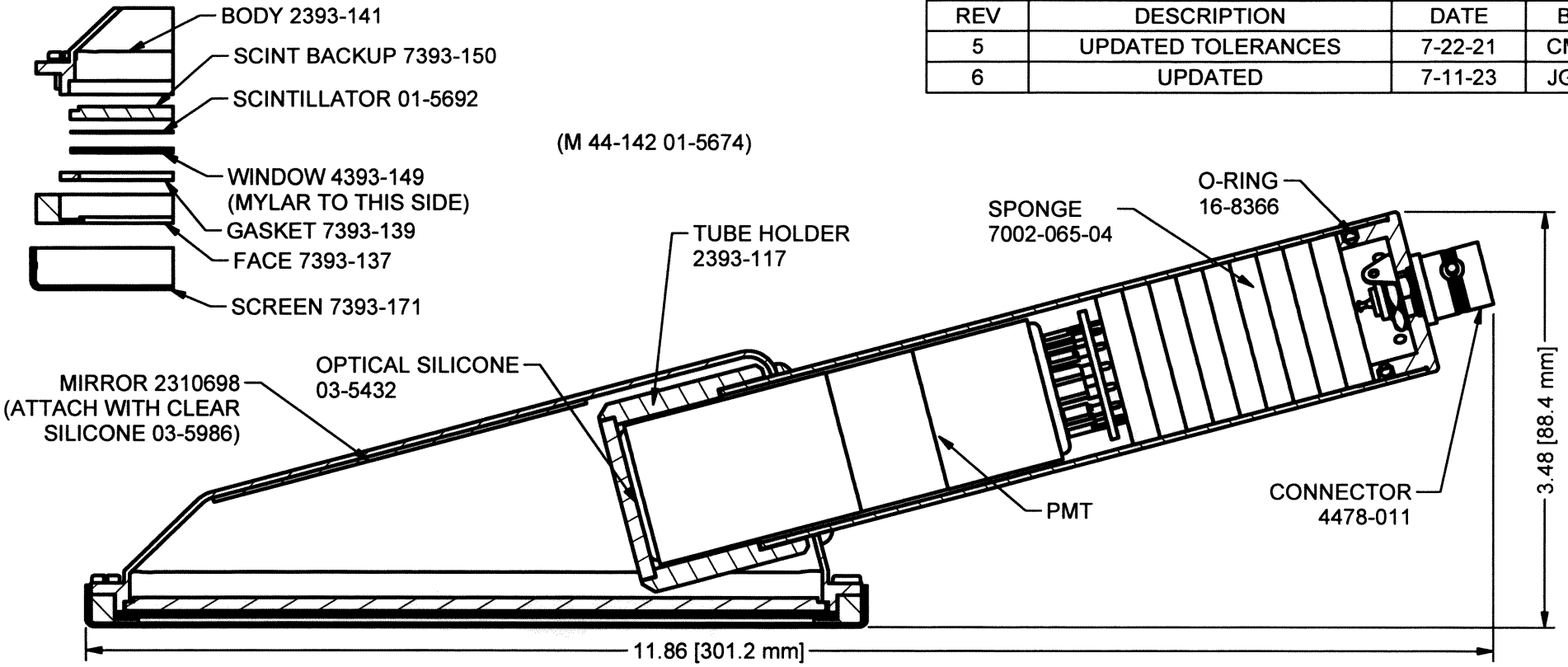

VOLUME:
APPROX 44 IN3

DWN	DATE	CHK	DATE	APP	DATE
JGW	7-11-23			JGW	7-11-23
DWG NUM: 4393-140				SCALE: 3/4	
TITLE M43-93, 44-142 W/ SNAP ON SCRN					
LUDLUM MEASUREMENTS, INC. 501 OAK STREET SWEETWATER, TEXAS 79556			SERIES 393	SHEET 140	

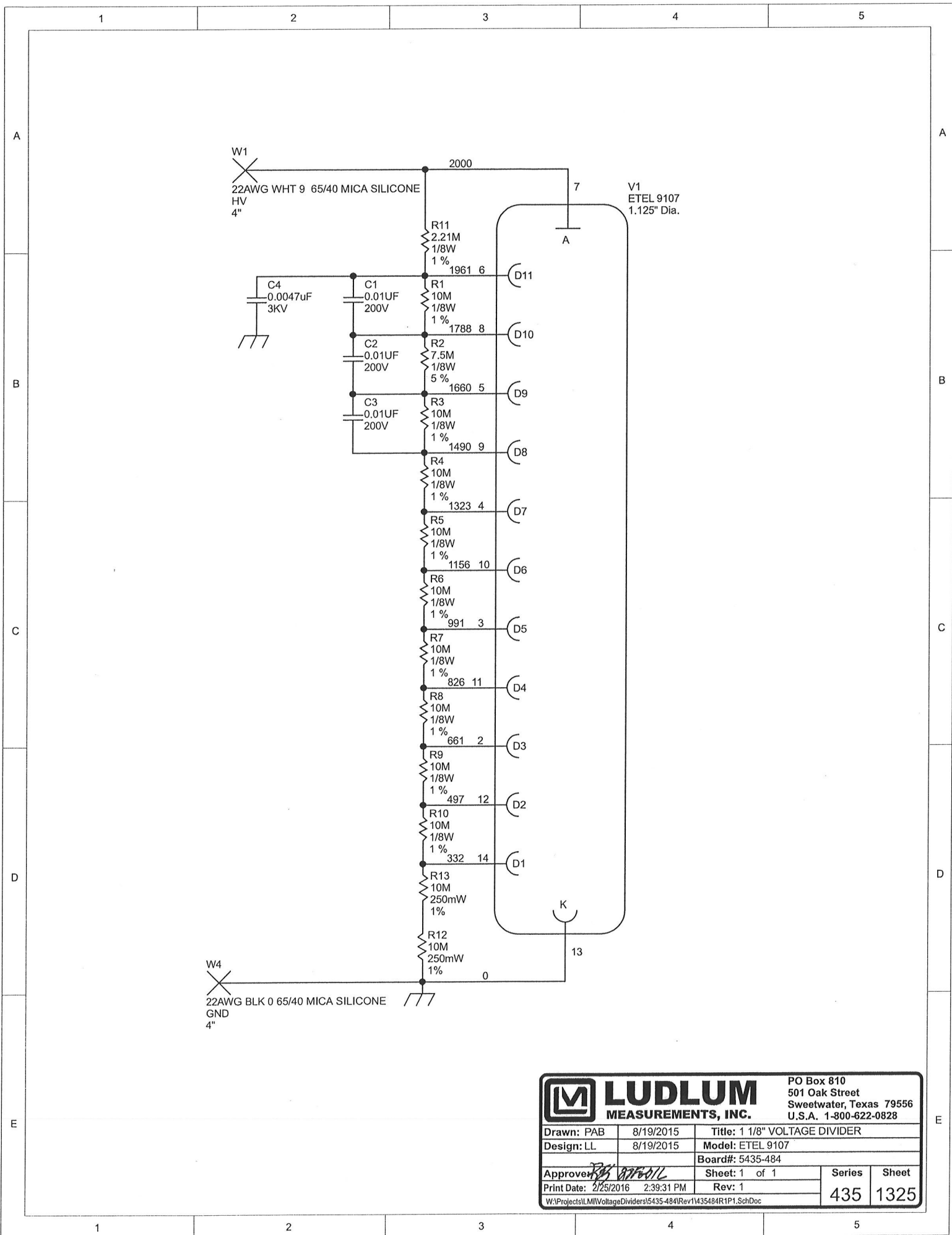

		PO Box 810 501 Oak Street Sweetwater, Texas 79556 U.S.A. 1-800-622-0828	
Drawn: PAB	8/19/2015	Title: 1 1/8" VOLTAGE DIVIDER	
Design: LL	8/19/2015	Model: ETEL 9107	
		Board#: 5435-484	
Approved: <i>[Signature]</i>	<i>[Signature]</i>	Sheet: 1 of 1	Series
Print Date: 2/25/2016 2:39:31 PM	Rev: 1	435	Sheet 1325
W:\Projects\LM\VoltageDividers\5435-484\Rev1\435484R1P1.SchDoc			

Bend C4 flat against board

Black Wire

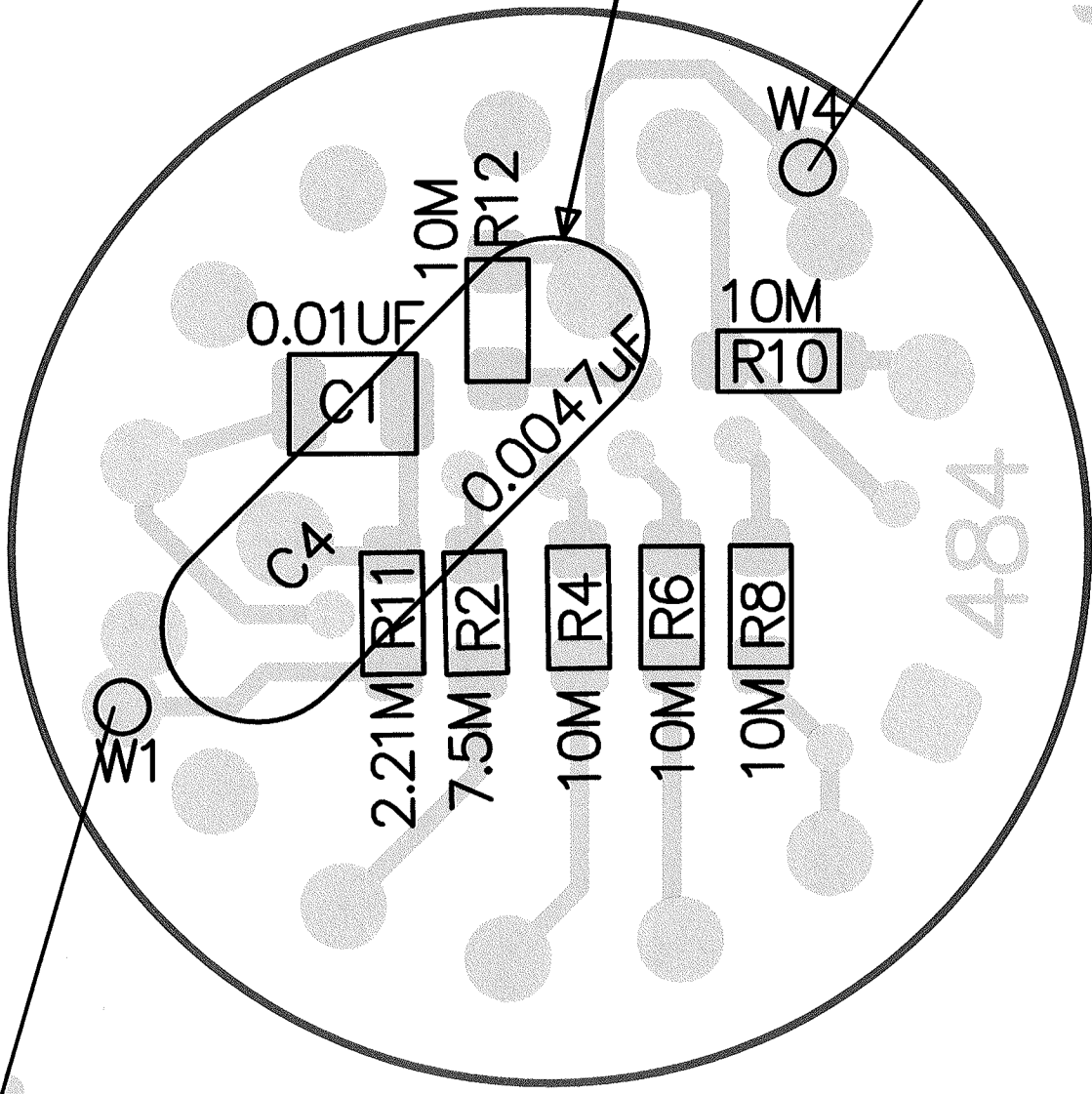

White Wire

2

		LUDLUM MEASUREMENTS, INC.		PO Box 810 501 Oak Street Sweetwater, TX 79556 U.S.A. 1-800-622-0828	
Title: 1 1/8" VOLTAGE DIVIDER					
Drawn:	PAB	8/19/2015	Model:	ETEL 9107	
Design:	LL	8/19/2015	Board#:	5435-484	
Approve:	<i>RDS</i>	<i>22 Nov 16</i>	Rev:	1	
PCBA Drawing			SCALE:	1.00	Series Sheet
Print Date:	6/22/2016	12:35:31 PM	Top Overlay	435	1324
W:\Projects\LMIVoltageDividers\5435-484\Rev1435484R1_Assy.PcbDoc					

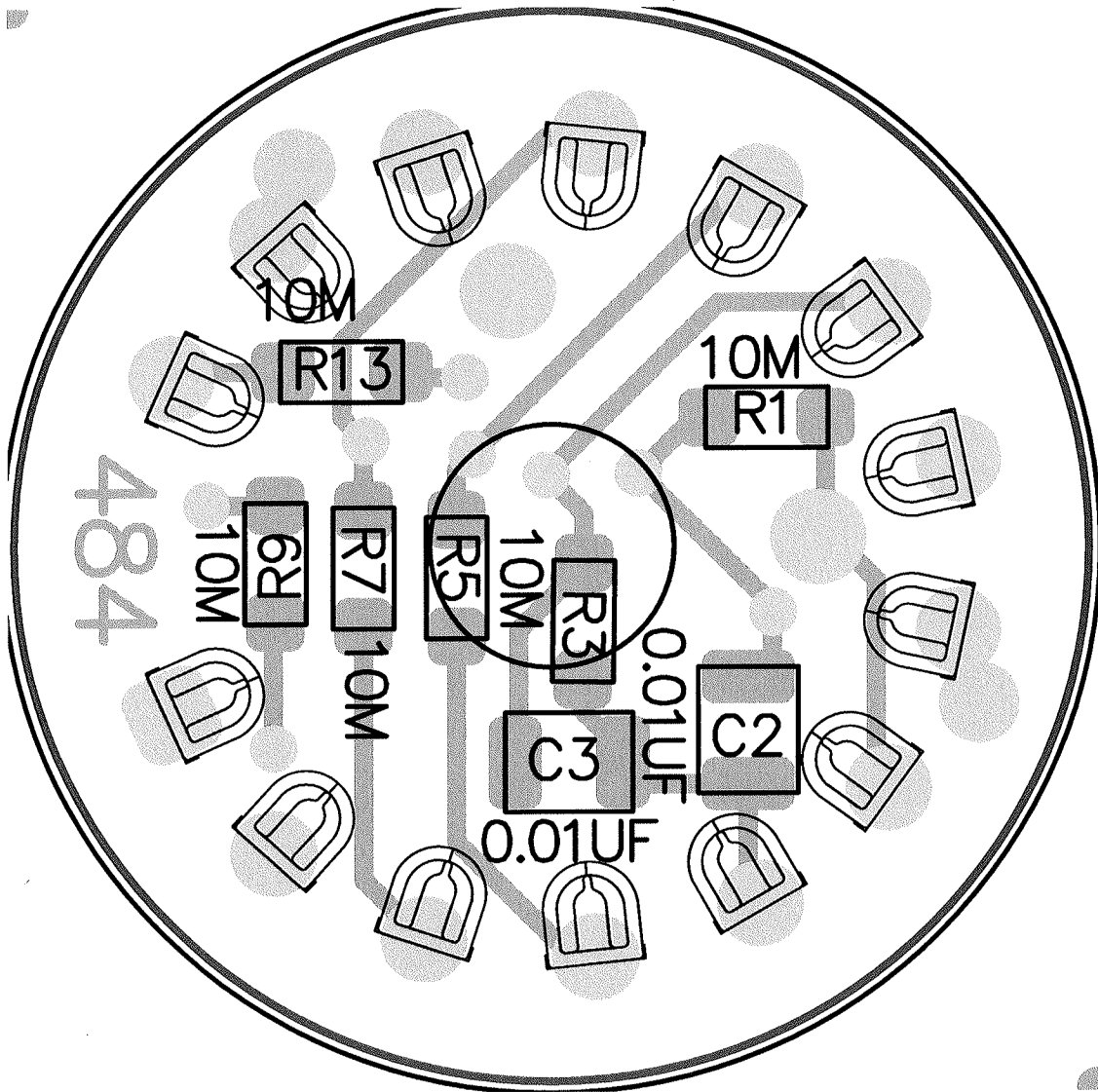

2

 LUDLUM MEASUREMENTS, INC.		PO Box 810 501 Oak Street Sweetwater, TX 79556 U.S.A. 1-800-622-0828	
Title: 1 1/8" VOLTAGE DIVIDER			
Drawn: PAB	8/19/2015	Model: ETEL 9107	
Design: LL	8/19/2015	Board#: 5435-484	
Approve: <i>RJS</i>	<i>22 Jun 2016</i>	Rev: 1	
<i>PCBA Drawing</i>		SCALE: 1.00	Series Sheet
Print Date: 6/22/2016	12:35:36 PM	Bottom Overlay	435 1324
<small>W:\Projects\LMIVoltageDividers\5435-484\Rev1\435484R1_Assy.PcbDoc</small>			