

**LUDLUM MODEL 12
SURVEY METER**

June 2025

**Serial Number 218039 and Succeeding
Serial Numbers**

**LUDLUM MODEL 12
SURVEY METER**

June 2025

**Serial Number 218039 and Succeeding
Serial Numbers**



LUDLUM MEASUREMENTS, INC
501 OAK STREET, P.O. BOX 810
SWEETWATER, TEXAS 79556
325-235-5494, FAX: 325-235-4672

STATEMENT OF WARRANTY

Ludlum Measurements, Inc. warrants the products covered in this manual to be free of defects due to workmanship, material, and design for a period of twelve months from the date of delivery. The calibration of a product is warranted to be within its specified accuracy limits at the time of shipment. In the event of instrument failure, notify Ludlum Measurements to determine if repair, recalibration, or replacement is required.

This warranty excludes the replacement of photomultiplier tubes, G-M and proportional tubes, and scintillation crystals which are broken due to excessive physical abuse or used for purposes other than intended.

There are no warranties, express or implied, including without limitation any implied warranty of merchantability or fitness, which extend beyond the description of the face there of. If the product does not perform as warranted herein, purchaser's sole remedy shall be repair or replacement, at the option of Ludlum Measurements. In no event will Ludlum Measurements be liable for damages, lost revenue, lost wages, or any other incidental or consequential damages, arising from the purchase, use, or inability to use product.

RETURN OF GOODS TO MANUFACTURER

If equipment needs to be returned to Ludlum Measurements, Inc. for repair or calibration, please send to the address below. All shipments should include documentation containing return shipping address, customer name, telephone number, description of service requested, and all other necessary information. Your cooperation will expedite the return of your equipment.

**LUDLUM MEASUREMENTS, INC.
ATTN: SERVICE DEPARTMENT
501 OAK STREET
SWEETWATER, TX 79556**

**800-622-0828 325-235-5494
FAX 325-235-4672**

Table of Contents

<i>Introduction</i>	1
<i>Getting Started</i>	2
Unpacking and Repacking	2-1
Battery Installation	2-1
Connecting a Detector to the Instrument	2-2
Battery Test	2-2
Instrument Test	2-2
Reading the Meter Face Dial	2-3
Operational Check	2-6
<i>Specifications</i>	3
<i>Identification of Controls and Functions</i>	4
<i>Safety Considerations</i>	5
Environmental Conditions for Normal Use	5-1
Warning Markings and Symbols	5-1
Cleaning and Maintenance Precautions	5-2
<i>Calibration and Maintenance</i>	6
Calibration	6-1
True Reading Calibration	6-1
Internal Calibration after overhaul	6-2
Establishing an Operating Point	6-3
Maintenance	6-4
Recalibration	6-5
Batteries	6-5
<i>Troubleshooting</i>	7
Troubleshooting Electronics which utilize a GM, Scintillator, or Proportional Detector	7-1
Troubleshooting GM Detectors	7-3

Troubleshooting Scintillators	7-4
Troubleshooting Proportional Detectors	7-4
<i>Technical Theory of Operation</i>	<i>8</i>
Main Board (Drawing 464 × 275 3 sheets)	8-1
Input	8-1
Amplifier	8-1
Discriminator	8-1
Audio	8-1
Scale Ranging	8-2
Digital Analog Converter	8-2
Ratemeter Drive Circuit	8-2
HV Meter Drive	8-2
Battery Test	8-2
HV Power Supply Board (Drawing 464 × 243)	8-3
Switching Convertor	8-3
Feedback	8-3
Voltage Control	8-3
Filtering	8-3
<i>Recycling</i>	<i>9</i>
<i>Parts List</i>	<i>10</i>
Model 12 Survey Meter	10-1
Main Board, Drawing 464 × 275	10-1
HV Power Supply Board, Drawing 464 × 243	10-4
Wiring Diagram, Drawing 464 × 309	10-5
<i>Drawings and Diagrams</i>	<i>11</i>

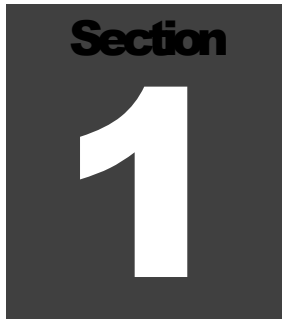
A dark gray square graphic with the word "Section" in white at the top and a large white number "1" in the center.

Introduction

The Model 12 is a portable survey meter with four linear ranges used in combination with exposure rate or CPM meter dials. The instrument features a regulated high-voltage power supply, unimorph speaker with audio ON-OFF capability, fast-slow meter response, meter reset button, and a six-position switch for selecting battery check or range multiples of $\times 1$, $\times 10$, $\times 100$, and $\times 1000$. Each range multiplier has its own calibration potentiometer. The unit body and meter housing are made of cast aluminum, and the can is 0.23 cm (0.09 in.) thick aluminum.

The audio provides a brief “click” for every radiation event detected. It also provides a steady tone to warn the user of a low-battery condition. This low battery warning overrides the position of the AUD ON-OFF switch.

With an adjustable detector voltage of 400-2500 volts and adjustable discriminator of 1-100 millivolts, this unit can be operated with most proportional, scintillation, or GM detectors. Scintillation detectors will require voltage divider circuit resistance in excess of 50 megohms.

The unit is operated with two “D” cell batteries for operation -20 to 50 °C (-4 to 122 °F). For instrument operation below 0 °C (32 °F), either very fresh alkaline or rechargeable NiCd batteries should be used.

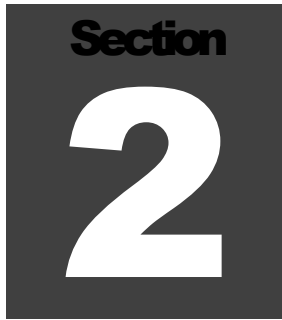
A dark gray square with the word "Section" in white at the top and a large white number "2" in the center.

Getting Started

Unpacking and Repacking

Remove the calibration certificate and place it in a secure location. Remove the instrument and accessories (batteries, cable, etc.) and ensure that all of the items listed on the packing list are in the carton. Check individual item serial numbers and ensure calibration certificates match. The Model 12 serial number is located on the front panel below the battery compartment. Most Ludlum Measurements, Inc. detectors have a label on the base or body of the detector for model and serial number identification.

Important!

If multiple shipments are received, ensure that the detectors and instruments are not interchanged. Each instrument is calibrated to specific detectors, and therefore not interchangeable.

To return an instrument for repair or calibration, provide sufficient packing material to prevent damage during shipment. Also provide appropriate warning labels to ensure careful handling. Include detector(s) and related cable(s) for calibration.

Every returned instrument must be accompanied by an **Instrument Return Form**, which can be downloaded from the Ludlum website at www.ludlums.com. Find the form by clicking the “Support” tab and selecting “Service Department” from the drop-down menu. Then choose the appropriate Service Department division where you will find a link to the form.

Battery Installation

Ensure the Model 12 range selector switch is in the OFF position. Open the battery lid by pushing down and turning the quarter-turn thumbscrew

counterclockwise a quarter of a turn. Install two “D” size batteries in the compartment.

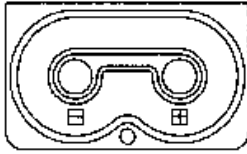

Note the (+) and (-) marks inside the battery door. Match the battery polarity to these marks. Close the battery box lid, push down, and turn the quarter-turn thumb screw clockwise a quarter of a turn.

Note:

The center post of a “D” size battery is positive.

Connecting a Detector to the Instrument

Caution!

The detector operating voltage (HV) is supplied to the detector via the detector input connector. A mild electric shock may occur if you make contact with the center pin of the input connector. Switch the Model 12 range selector switch to the OFF position before connecting or disconnecting the cable or detector.

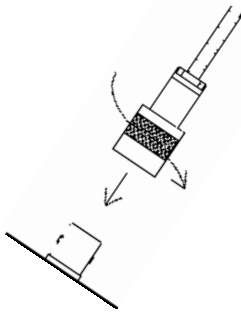

Connect one end of a detector cable to the detector by firmly pushing the connectors together while twisting clockwise a quarter of a turn. Repeat the process in the same manner with the other end of the cable and the instrument.

Battery Test

Check the batteries daily or prior to use, whichever is less frequent, to assure proper operation of the instrument. Move the range multiplier switch to the BAT position. Ensure that the meter needle deflects to the battery check portion on the meter scale. If the meter does not respond, check to see if the batteries have been correctly installed. Replace the batteries if necessary.

Instrument Test

After checking the batteries, turn the instrument range switch to the $\times 1000$ position. Place the AUD ON-OFF switch in the ON position. Expose the detector to a check source. The instrument speaker should emit “clicks” relative to the rate of counts detected. The AUD ON/OFF switch will silence

the audible clicks if in the OFF position. It is recommended that the AUD ON/OFF switch be kept in the OFF position when not needed in order to preserve battery life.

The detector cable can be a source of problems. Test the detector cable by bending and flexing either end of the cable and checking for an increase in the rate of counts detected. Replace the cable if an increase in the rate of counts is detected.

Check the meter reset function by depressing the RES pushbutton switch and ensuring the meter needle drops to “0.”

Once this procedure has been completed, the instrument is ready for use.

Reading the Meter Face Dial

Reading the meter face is very important for consistent measurements. There are, in general, three types of meter faces: 1) count rate (typically cpm [counts per minute]); 2) exposure rate (typically mR/hr); and 3) “combo” (typically cpm and mR/hr). The following examples are intended to help the user interpret the correct reading.

The normal procedure is to turn the range selector switch to the highest range and if no readings are seen on the meter, turn the selector switch down to the lower scales until a reading is seen. The ranges on the instrument selector switch are multipliers for the meter reading. A typical single scale (one arc) meter face with a cpm (counts per minute) dial is shown below.

The count rate scale reads 0-5K COUNTS/MINUTE (kcpm or 1000’s of counts per minute) and has BAT TEST on the dial.



If the needle is pointing as indicated below and the instrument range selection switch is on the $\times 0.1$ scale multiple, then the reading is 3.5 kcpm (multiplied by) $\times 0.1 = 350$ cpm.



The same needle indications on successive ranges would be:

$$\times 1 = 3.5 \text{ kcpm (or 3500 cpm)}$$

$$\times 10 = 35 \text{ kcpm (or 35,000 cpm)}$$

$$\times 100 = 350 \text{ kcpm (or 350,000 cpm)}$$

A typical dual scale (two arcs) meter face is shown below. The top scale reads 0-2 mR/hr. The bottom scale also reads 0-2 mR/hr and is for $\times 100$ scale only. The $\times 100$ ONLY scale will work correctly when the multiplier switch is in the $\times 100$ range. The meter face also has a BAT TEST position on the dial.

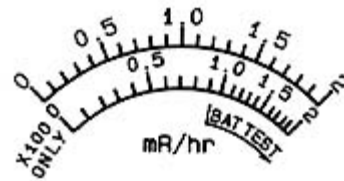

If the needle is pointing as indicated below and the range selection switch is on the $\times 0.1$ scale, then the reading is 0.1 mR/hr.



The same needle indications on successive ranges would be:

$$\times 1 = 1.0 \text{ mR/hr (or 1,000 } \mu\text{R/hr)}$$

$$\times 10 = 10 \text{ mR/hr (or 10,000 } \mu\text{R/hr)}$$

$$\times 100 = 70 \text{ mR/hr (or 70,000 } \mu\text{R/hr)}$$

The dial shown below has three arcs: a counts per minute scale (cpm), a linear mR/hr scale, and a non-linear mR/hr scale for the $\times 100$ range only. The meter face also has a BAT TEST position.



The top cpm scale is valid for the $\times 0.1$, $\times 1$, $\times 10$, and the $\times 100$ ranges. The linear (middle) mR/hr scale is valid for the $\times 0.1$, $\times 1$, and $\times 10$ ranges. The non-linear mR/hr scale is valid for the $\times 100$ range only. This meter face is commonly referred to as a “combo” meter face since it has both count rate (cpm) and exposure rate (mR/hr) arcs. Simpler meter faces may only have a count rate or an exposure rate arc(s) like the previous meter faces shown.

A “combo” meter face is specifically designed for a particular detector. In the example above, the 1.0 mR/hr mark on the middle arc lines up with 3.3 kcpm on the upper arc. The meter face in this example works with a detector that receives 3.3 kcpm per mR/hr (the Ludlum Model 44-9 pancake detector.)

In the following picture, the needle is on the first tick mark past the 4 kcpm mark. Therefore, if the instrument selector switch is on the $\times 0.1$ range, the reading is 4.2 kcpm (multiplied by) $\times 0.1 = 420$ cpm.



The same needle indications on successive ranges would be:

$$\times 1 = 4.2 \text{ kcpm (or 4,200 cpm)}$$

$$\times 10 = 42 \text{ kcpm (or 42,000 cpm)}$$

$$\times 100 = 420 \text{ kcpm (or 420,000 cpm)}$$

If you use the mR/hr scales, then the readings would be:

$$\times 0.1 = 0.13 \text{ mR/hr}$$

$$\times 1 = 1.3 \text{ mR/hr}$$

$$\times 10 = 13 \text{ mR/hr}$$

$$\times 100 = 180 \text{ mR/hr*}$$

Note:

*This reading is using the bottom (non-linear) scale.

Many different dials are available, but each can be used as described above.

Operational Check

To assure proper operation of the instrument and detector(s) between calibrations, an instrument operational check including battery test and instrument test (as described above) should be performed at least daily or prior to use, whichever is less frequent. A reference reading(s) with a check source should be obtained with the detector(s) in a constant and reproducible manner at the time of calibration or at the time the instrument is received in the field.

If at anytime the instrument fails to read within 20% of the reference reading when using the same check source, it should be sent to a calibration facility for recalibration and/or repair. If desired, multiple readings may be taken at different distances and/or with different sources so that other ranges or scales are checked.

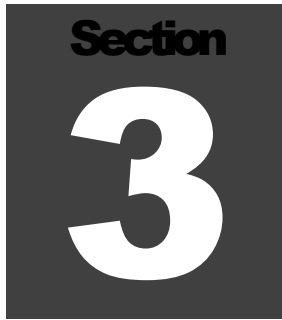
A dark gray square with the word "Section" in white at the top and a large white number "3" in the center.

Specifications

Multipliers: $\times 1$, $\times 10$, $\times 100$, and $\times 1000$ selected by a front-panel range selector switch

High Voltage: adjustable from 400 to 2500 volts; can be read on the meter; electronically regulated to 1%; support of scintillation loads to 1500 volts, proportional loads to 2500 volts

Input Sensitivity: adjustable from -1 to -100 mV

Input Impedance: 0.1 megohm

Meter: 6.4 cm (2.5 in.) arc, 1 mA analog type

Meter Dial: 0-500 cpm, 0-2.5 kV, BAT TEST (others available)

Range: typically 0-500,000 counts/minute (CPM)

Linearity: reading within 10% of true value with detector connected

Calibration Controls: individual potentiometers for each range; accessible from the front cover while in operational status

Response: toggle switch for FAST (4 seconds) or SLOW (22 seconds) from 10% to 90% of final reading

Connector: Series "C" (other available)

Cable: 39-inch with "C" connector

Reset: pushbutton to zero the meter

Audio: built-in unimorph speaker with ON-OFF switch (greater than 60 dB at 0.61 m {2 ft})

Power: two "D" cell batteries housed in a sealed externally accessible compartment

Battery Dependence: instrument calibration change less than 3% within battery check limits on the meter

Battery Life: typically 2000 hours with alkaline batteries (battery condition may be checked on the meter)

End-of-Battery Life Warning: At 2.1 Vdc, the meter needle will drop to the edge of the BAT TEST or BAT OK area when the meter selector switch is moved to the BAT position. At 2.0 Vdc, a steady audible tone will be emitted to warn the user of the low-battery condition.

Size: 16.5 x 8.9 x 21.6 cm (6.5 x 3.5 x 8.5 inch) (H x W x L)

Weight: 1.6 kg (3.5 lb) including batteries.

Construction: cast-and-drawn aluminum with beige powder coating

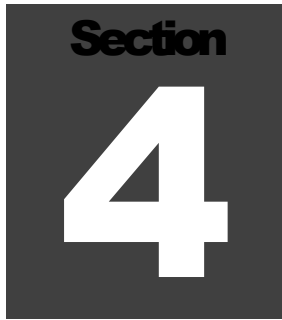
A dark gray square containing the word "Section" in a small, white, sans-serif font at the top, and a large, white, bold number "4" in the center.

Identification of Controls and Functions

See the Model 12 front-panel drawing at the beginning of this manual to reference the following controls:

(A) Meter: 6.4 cm (2.5 in.) arc, 1 mA analog type with pivot-and-jewel suspension. Typical meter dials are 0-0.2 mR/hr, 0-2.0 μ Sv/h, 0-500 cpm or combination of exposure rates (0-0.2 mR/hr or 0-2.0 μ Sv/h), and cpm and BAT TEST.

(B) Connector: Used to connect the detector to the instrument. Typically series "C" but can be "BNC," "MHV," "UHF" or others.

(C) Range Selector Switch: A six-position switch marked OFF, BAT, $\times 1000$, $\times 100$, $\times 10$, and $\times 1$. Turning the range selector switch from OFF to BAT provides the operator with a battery check of the instrument. A BAT check scale on the meter provides a visual means of checking the battery-charge status. Moving the range selector switch to one of the range multiplier positions ($\times 1000$, $\times 100$, $\times 10$, $\times 1$) provides the operator with four decades of an overall range. Multiply the scale reading by the multiplier to determine the actual scale reading.

(D) Discriminator Adjustment: allows the input sensitivity to be adjusted from 1 to 100 millivolts (mV).

(D) HV Adjustment: provides a means of varying the high voltage (HV) from 400 to 2500 volts.

(D) Range Calibration Adjustment: recessed potentiometers located under the calibration cover, on the right side of the front panel. These adjustment controls allow individual calibration for each range multiplier.

(E) Battery Compartment: sealed compartment to house two "D" cell batteries.

(F) RES Pushbutton Switch: when depressed, this switch provides a rapid means of driving the meter needle to zero.

(G) AUD ON-OFF Toggle Switch: In the ON position, this operates the unimorph speaker, located on the left side of the instrument. The frequency of the clicks is relative to the rate of the incoming pulses. The higher the rate, the higher the audio frequency. The audio should be turned OFF when not required to reduce battery drain.

Note:

A low-battery condition results in a steady audio tone, regardless of the position of the AUD ON/OFF switch.

(H) F-S Toggle Switch: Provides meter response. Selecting the fast, "F" position, of the toggle switch provides 90% of full-scale meter deflection in four seconds. In the slow, "S" position, 90% of full-scale meter deflection takes 22 seconds. In the "F" position there is fast response and large meter deviation. The "S" position should be used for slow response and damped meter deviation.

Note:

The slow response position is normally used when the instrument is displaying low numbers, which require a more stable meter movement. The fast response position is used at high rate levels.

(I) HV Pushbutton Switch: When depressed, displays the detector high voltage on the meter. The output resistance of the HV supply is 1.5 megohms with a typical scintillation voltage divider of 100 megohms. The actual detector voltage will be 98.5% of the indicated voltage.

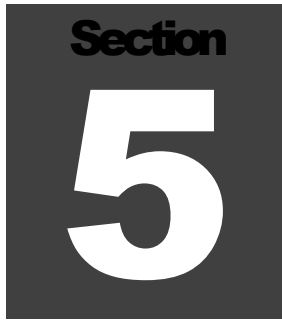
A dark gray square containing the word "Section" in a small, white, sans-serif font at the top, and a large, white, bold number "5" in the center.

Safety Considerations

Environmental Conditions for Normal Use

The detector may be affected by altitude. Refer to the detector manual for more information.

Indoor or outdoor use

No maximum altitude

Temperature range of -20 to 50 °C (-4 to 122 °F); may be certified for operation from -40 to 65 °C (-40 to 150 °F)

Maximum relative humidity of less than 95% (non-condensing)

Pollution Degree 3 (as defined by IEC 664) (Occurs when conductive pollution or dry nonconductive pollution becomes conductive due to condensation. This is typical of industrial or construction sites.)

Warning Markings and Symbols

Caution!

The operator or responsible body is cautioned that the protection provided by the equipment may be impaired if the equipment is used in a manner not specified by Ludlum Measurements, Inc.

The Model 12 Survey Meter is marked with the following symbols:



CAUTION, RISK OF ELECTRIC SHOCK (per ISO 3864, No. B.3.6) – designates a terminal (connector) that allows connection to a voltage exceeding 1 kV. Contact with the subject connector while the instrument is on or shortly after turning off may result in electric shock. This symbol appears on the front panel.



CAUTION (per ISO 3864, No. B.3.1) – designates hazardous live voltage and risk of electric shock. During normal use, internal components are hazardous live. This instrument must be isolated or disconnected from the hazardous live voltage before accessing the internal components. This symbol appears on the front panel. **Note the following precautions:**

Warning!

The operator is strongly cautioned to take the following precautions to avoid contact with internal hazardous live parts that are accessible using a tool:

1. Turn the instrument power OFF and remove the batteries.
2. Allow the instrument to sit for one minute before accessing internal components.



The “**crossed-out wheelie bin**” symbol notifies the consumer that the product is not to be mixed with unsorted municipal waste when discarding; each material must be separated. The symbol is placed on the battery compartment lid. See section 9, “Recycling,” for further information.



The “CE” mark is used to identify this instrument as being acceptable for use within the European Union. It is located on the battery lid.

Cleaning and Maintenance Precautions

The Model 12 may be cleaned externally with a damp cloth, using only water as the wetting agent. Do not immerse the instrument in any liquid. Observe the following precautions when cleaning or performing maintenance on the instrument:

1. Turn the instrument OFF and remove the batteries.
2. Allow the instrument to sit for one minute before cleaning the exterior or accessing any internal components for maintenance.

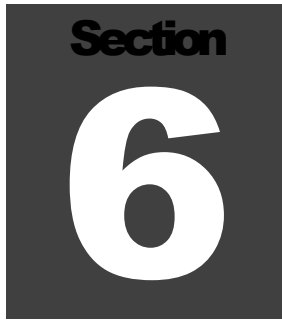
A dark gray square with the word "Section" in white at the top and a large white number "6" in the center.

Calibration and Maintenance

Calibration

Calibration controls are located on the front of the instrument under the calibration cover. The controls may be adjusted with a 1/8-inch blade screwdriver.

Note:

Local procedures may supersede the following

The instrument may be calibrated to true reading or, when used with a single source, geometry calibration may be used. Both methods are described below. Unless otherwise specified, the instrument is calibrated to true reading at the factory.

Note:

Measure high voltage with a Model 500 Pulser or a high-impedance voltmeter with a high-meg probe. If one of these instruments is not available, use a voltmeter with a minimum of 1000 megohm input resistance.

True Reading Calibration

Connect the input of the instrument to a negative pulse generator, such as a Ludlum Model 500 Pulser.

Caution!

The instrument input operates at a high potential. Connect the pulse generator through a 0.01 μ F, 3000-volt capacitor, unless the pulse generator is already protected.

Adjust the pulser frequency to correspond to the 3/4-scale value of the instrument. Increase the Pulser output voltage until the pulse height is twice the input sensitivity. Adjust the calibration potentiometer for a 3/4-scale reading. Repeat for each range.

To correlate this calibration to a detected radiation value, the probe efficiency must be determined. Select the operating point for the probe used as outlined in the following section. Then determine the count rate with the probe exposed to a calibration source. The ratio of the instrument count rate versus the known source value is the probe efficiency. This degree will be different for various types of probes and sources. By using probe efficiency, one determines the actual emission rate of an unknown source.

Note:

For proportional and scintillation detectors, changes in the HV and DIS controls will change the apparent detector efficiency for many sources.

Geometry calibration is often used when the instrument is utilized to measure radiation with a limited spectrum; for example, a single isotope calibration. To calibrate the instrument using this technique, obtain calibration sources with a spectrum similar to the target radiation. Expose the probe to the source and adjust the calibration control until the meter reading corresponds to the source value. Repeat this procedure with scaled sources for each instrument range.

In the event that only one source is available, calibrate the corresponding range to that source. Disconnect the probe and connect a pulse generator to the instrument. Determine the pulse rate for 3/4-scale deflection on the calibrated range. Using this reading as a reference, calibrate each succeeding range by increasing (or decreasing) this rate by a factor of 10 for each.

Internal Calibration after Overhaul

Connect instrument to a Model 500 Pulser. Adjust the front-panel HV adjustment for a pulser high-voltage meter reading of 1500 volts. Depress the HV pushbutton while adjusting the main board HV SET potentiometer (R38) for a Model 12 meter reading of 1500 volts.

Establishing an Operating Point

The operating point for the instrument and probes is established by setting the probe voltage and instrument sensitivity (HV and DIS). The proper selection of this point is the key to instrument performance. Efficiency, background sensitivity and noise are fixed by the physical makeup of the given detector and rarely vary from unit to unit. However, the selection of the operating point makes a marked difference in the apparent contribution of these three sources of count.

In setting the operating point, the final result of the adjustment is to establish the system gain so that the desirable signal pulses (including background) are above the discrimination level and the unwanted pulses from noise are below the discrimination level and are therefore not counted.

Adjusting either the instrument gain or the high voltage controls the total system gain. Voltage affects control in the probe; DIS (Discriminator) controls the amplifier gain.

In the special case of GM detectors, a minimum voltage must be applied to establish the Geiger-Mueller (GM) characteristic. Further changes in gain will not affect this type of probe.

The operating point for each detector is set at a compromise point of sensitivity, stability, and background contribution. These operating points are best for general monitoring. In application, these arbitrarily selected points may not be a better operating point. The following guides are presented:

GM Detectors: The output pulse height of the GM Detector is not proportional to the energy of the detected radiation.

Adjusting DIS will have minimal effect on the observed count rate unless the DIS setting is so low that the instrument will double-pulse.

For most GM Detectors, set DIS for 30-40 millivolts and adjust HV to the GM tube recommended high voltage. Most GM detectors operate at 900 volts, although, some miniature detectors operate at 400-500 volts. If a recommended setting is unavailable, plot a HV versus count rate curve to produce a plateau graph similar to the one on the following page. Then set DIS on the low side of center. For mixed detector use, both sensitivity and high voltage may be adjusted for the other detectors

as long as the high voltage setting is above the minimum required by the GM tube.

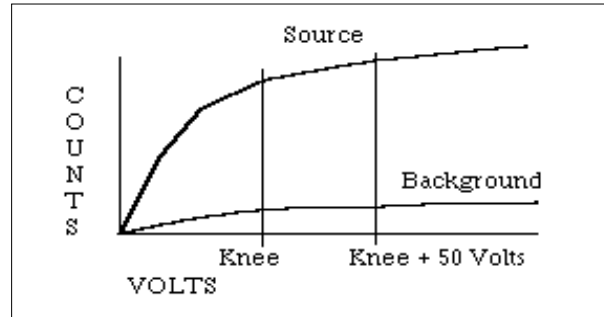

Proportional Detectors: Set the DIS control for 2-millivolt discrimination (near maximum clockwise). Expose the detector to a check source. Adjust the HV until the low-energy source is detected. Refine the HV adjustment for an optimum source count with a minimum acceptable background count.

Air Proportional Alpha Detectors: Set the DIS for one-millivolt discrimination. Adjust the HV until the detector just breaks down (shown by a rapid increase of count rate without a source present). Measure the HV output; then decrease the HV setting to operate 100 volts below breakdown.

Scintillators: Set the DIS for 10 millivolts. Carefully increase the HV until the instrument plateaus on the background count. This provides the most stable operating point for the detector.

Check the calibration and proceed to use the instrument.

Maintenance

Instrument maintenance consists of keeping the instrument clean and periodically checking the batteries and the calibration. The Model 12 instrument may be cleaned with a damp cloth (using only water as the wetting agent). Do not immerse instrument in any liquid. Observe the following precautions when cleaning:

1. Turn the instrument OFF and remove the batteries.
2. Allow the instrument to sit for one minute before accessing internal components.

Recalibration

Recalibration should be accomplished after maintenance or adjustments have been performed on the instrument. Recalibration is not normally required following instrument cleaning or battery replacement.

Note:

Ludlum Measurements, Inc. recommends recalibration at intervals no greater than one year. Check the appropriate regulations to determine required recalibration intervals.

Ludlum Measurements offers a full-service repair and calibration department. We not only repair and calibrate our own instruments, but most other manufacturers' instruments as well. Calibration procedures are available upon request for customers who choose to calibrate their own instruments.

Batteries

The batteries should be removed any time the instrument is placed into storage. Battery leakage may cause corrosion on the battery contacts, which must be scraped off and/or washed using a paste solution made from baking soda and water. Use a spanner wrench to unscrew the battery contact insulators, exposing the internal contacts and battery springs. Removal of the handle will facilitate access to these contacts.

Note:

Never store the instrument over 30 days without removing the batteries. Although this instrument will operate at very high ambient temperatures, battery seal failure may occur at temperatures as low as 37 °C (100 °F).

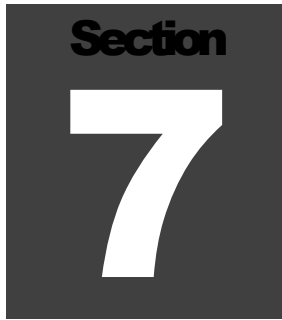
A dark gray square containing the word "Section" in a bold, white, sans-serif font at the top, and a large, white, bold number "7" in the center.

Troubleshooting

Occasionally you may encounter problems with your LMI instrument or detector that may be repaired or resolved in the field, saving turn-around time and expense in returning the instrument to us for repair. Toward that end, LMI electronics technicians offer the following tips for troubleshooting the most common problems. Where several steps are given, perform them in order until the problem is corrected. Keep in mind that with this instrument, the most common problems encountered are: (1) detector cables, (2) sticky meters, and (3) battery contacts.

Note that the first troubleshooting tip is for determining whether the problem is with the electronics or with the detector. A Ludlum Model 500 Pulser is invaluable at this point, because of its ability to simultaneously check high voltage, input sensitivity or threshold, and the electronics for proper counting.

We hope these tips will prove to be helpful. As always, please call if you encounter difficulty in resolving a problem or if you have any questions.

Troubleshooting Electronics which utilize a GM, Scintillator, or Proportional Detector

SYMPTOM

No power (or meter does not reach BAT TEST or BAT OK mark)

POSSIBLE SOLUTION

1. Check batteries and replace if weak.
2. Check polarity (see marks inside battery lid). Are the batteries installed backwards?

<u>SYMPTOM</u>	<u>POSSIBLE SOLUTION</u>
No power (or meter does not reach BAT TEST or BAT OK mark) (continued)	<ol style="list-style-type: none">3. Check battery contacts. Clean them with rough sandpaper or use an engraver to clean the tips.4. Check for loose or broken wires, especially between the main board and the calibration board.
Non-linear readings	<ol style="list-style-type: none">1. Check the high voltage (HV) by pressing the HV TEST button. If a multimeter is used to check the HV, ensure that one with high impedance is used, as a standard multimeter could be damaged in this process.2. Check for noise in the detector cable by disconnecting the detector, placing the instrument on the lowest range setting, and wiggling the cable while observing the meter face for significant changes in readings.3. Check for “sticky” meter movement. Does the reading change when you tap the meter? Does the meter needle “stick” at any spot?4. Check the “meter zero.” Turn the power OFF. The meter should come to rest on “0”.
Meter goes full-scale or “pegs out”	<ol style="list-style-type: none">1. Replace the detector cable to determine whether or not the cable has failed- causing excessive noise.2. Check the HV and, if possible, the input threshold for proper setting.

<u>SYMPTOM</u>	<u>POSSIBLE SOLUTION</u>
Meter goes full-scale or “pegs out” (continued)	<ol style="list-style-type: none"> 3. Check for loose wires, especially between the main board and the calibration board. 4. Ensure that the instrument’s “can” is properly attached. When attached properly, the speaker will be located on the left side of the instrument. If the can is on backwards, interference between the speaker and the input preamplifier may cause noise.
No response to radiation	<ol style="list-style-type: none"> 1. Substitute a “known good” detector and/or cable. 2. Has the correct operating voltage been set? Refer to the calibration certificate or detector instruction manual for correct operating voltage. If the instrument uses multiple detectors, confirm that the high voltage is matched to the current detector being used.
No audio	<ol style="list-style-type: none"> 1. Ensure that the AUD ON-OFF switch is in the ON position. 2. Remove the instrument housing and check the connection between the circuit board and the speaker. Plug in the 2-pin connector if necessary.

Troubleshooting GM Detectors

1. If the tube has a thin mica window, check for window breakage. If damage is evident, the tube must be replaced.
2. Check the HV. For most GM tubes, the voltage is normally 900 Vdc, or 460-550 Vdc for “peanut” tubes (Ludlum Model 133 series).

3. If the input sensitivity is too low, the user could see some double-pulsing.
4. Wires to the tube may be broken or the crimped connector could have a loose wire.

Troubleshooting Scintillators

1. Alpha or alpha/beta scintillators are prone to light leaks. They can be tested for this problem in a dark room or with a bright light. If a light leak is determined, changing the metalized polyester window assembly will usually fix the problem.

Note:

When replacing the window, make sure to use a window made with the same thickness metalized polyester and the same number of layers as the original window.

2. Verify that the HV and input sensitivity are correct. Alpha and gamma scintillators typically operate from 10-35 mV. High voltage varies with the photomultiplier tubes (PMT) from as low as 600 Vdc, to as high as 1400 Vdc.
3. On a gamma scintillator, visually inspect the crystal for breakage or humidity leakage. Water inside the crystal will turn it yellow and gradually degrade performance.
4. Check the PMT to see if the photocathode still exists. If the end of the PMT is clear (not brownish), this indicates a loss of vacuum, which will render the PMT useless.

Troubleshooting Proportional Detectors

1. Check the HV and input sensitivity settings. In gross counting of alpha particles, gas proportional detectors normally operate at 1250 Vdc and -4 mV threshold. In gross counting of beta or alpha and beta particles, gas proportional detectors normally operate at 1650 Vdc and -4 mV threshold. In simultaneous counting of alpha and beta particles, the HV is normally about 1600 Vdc, the alpha threshold is normally -120 mV, and the beta threshold and window are normally -3.5 mV and -30 mV.

2. Neutron ^3He detectors typically require a -2 mV threshold and about 1700 Vdc. Neutron BF_3 detectors typically operate at 1750 Vdc and -30 mV threshold.
3. Gas proportional detectors need P-10 gas, so check the window for tears or leaks and ensure an adequate supply of gas.
4. If the window is torn, the anode wires are likely to be broken as well, shorting against the detector. Replace broken wires, clean the lacquer thinner, then bake at 93 °C (200 °F).
5. Humidity can also be a problem for proportional detectors. Dry and/or check the desiccants.

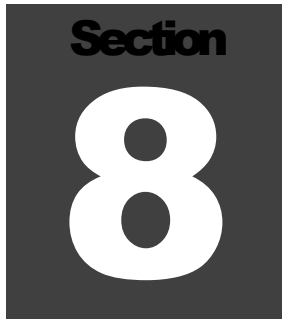
A dark gray square containing the word "Section" in a bold, sans-serif font at the top, and a large, white, bold number "8" in the center.

Technical Theory of Operation

MAIN BOARD (Drawing 464 × 275 with 3 sheets in back of manual)

Input

Detector pulses are coupled through C16 to emitter follower Q4. R42 provides 3.7 volt bias. R41 couples to detector high voltage. CR3 protects the input from high-voltage transients.

Amplifier

A self-biased amplifier provides gain in proportion to R15 divided by R14 and R47. Transistor (pin 3 of U4) provides amplification. U6 is coupled as current mirror to provide a load for pin 3 of U4. The output self-biases to 2 Vbe (approximately 1.4 volts) at emitter of Q1.

Positive pulses from Q1 are coupled to the discriminator U8. Amplifier gain is controlled by R47.

Discriminator

Comparator U8 has a fixed discrimination of 15 millivolts. Any pulse above 15 millivolts causes the output of U8 to go low. This negative pulse is coupled to pin 5 of U9A for meter drive and pin 12 of U9B for audio drive. The pulse is also available at pin 3 of P2 for special applications.

Audio

U9B develops a 22-millisecond pulse for each discriminator pulse if audio switch is ON, allowing pin 13 of U9B to be high. Pin 10 of U9B is normally low, preventing U12 from oscillating. When pulse goes high, U12 oscillates, driving the unimorph speaker. U7B is normally closed, but during low battery state, pin 5 of U7B opens, allowing R30 to pull pin 3 of U12 high, which causes a steady tone even though the audio is OFF.

Scale Ranging

Detector pulses from the discriminator are coupled to univibrator pin 5 of U9A. For each scale, the pulse width of pin 6 of U9A is increased by a factor of 10 with the actual pulse width being controlled by the front-panel calibration controls and their related capacitors. This arrangement allows the same current to be delivered to C9 by one count on the $\times 1$ range as 1,000 counts on $\times 1K$ range.

Digital Analog Converter

U5 is coupled as a current mirror. For each pulse of current through R24, an equal current is delivered to C9. This charge is drained off by R25. The voltage across C9 is proportional to the incoming count rate.

RateMeter Drive Circuit

Voltage across C9 is measured by voltage follower U10 and Q2. Q2 converts voltage input to a constant current output at Q2 collector. Current flow is controlled by R19. For slow time constant, C17 is switched from the output to parallel C9 at the input. Reset (SW2) shorts the input capacitor. R44 stabilizes U10. Meter current flows through analog switch U7A and U16B.

HV Meter Drive

A voltage proportional to high voltage is converted to a constant current drain by voltage follower U13 and Q3. Current flow is controlled by R49. This current is converted to a constant current source by U15, and then coupled to the meter through analog switch U3B.

Battery Test

Battery voltage is connected through R8 through analog switch U3A and U16B to the meter.

HV Supply Board (Drawing 464 × 243 in back of manual)

Switching Convertor

High voltage is developed by voltage multiplier CR1 through CR10 and associated capacitors. This multiplier is driven by switching convertor U2 and T1. The convertor is powered by regulated 6 volts from the main board.

Feedback

The high-voltage output is reduced 99.9% by voltage divider R4, R5, and R6. The remaining voltage is coupled to the HV meter circuit through R7 and pin 1 of P1. Also, the voltage is coupled through R8 to the switcher feedback input pin 8 of U2.

Voltage Control

The switching convertor U2 and T1 will develop an output voltage at C3 and R4, such that the voltage at pin 8 of U2 stays at 1.24 volts. If voltage at pin 2 is zero, voltage at pin 1 of U1 must be 2.541 volts to maintain 1.24 volts at pin 8 of U2. To obtain 2.541 volts at pin 1 of U2, the output voltage must be 2.541 volts. In like manner, as the voltage at pin 2 of P1 increases to 2.181 volts, the high-voltage output will be driven to zero.

Filtering

The high voltage is filtered by R2, R3, C1, and C2. R2 and R3 cause the power supply to have an output resistance of 1.5 MEG. This will cause a metering error for heavy loads. For the typical 100 MEG detector, this error will only represent 1.5%.

Section 9

Recycling

Ludlum Measurements, Inc. supports the recycling of the electronics products it produces for the purpose of protecting the environment and to comply with all regional, national, and international agencies that promote economically and environmentally sustainable recycling systems. To this end, Ludlum Measurements, Inc. strives to supply the consumer of its goods with information regarding reuse and recycling of the many different types of materials used in its products. With many different agencies – public and private – involved in this pursuit, it becomes evident that a myriad of methods can be used in the process of recycling. Therefore, Ludlum Measurements, Inc. does not suggest one particular method over another, but simply desires to inform its consumers of the range of recyclable materials present in its products, so that the user will have flexibility in following all local and federal laws.

The following types of recyclable materials are present in Ludlum Measurements, Inc. electronics products, and should be recycled separately. The list is not all-inclusive, nor does it suggest that all materials are present in each piece of equipment:

Batteries	Glass	Aluminum and Stainless Steel
Circuit Boards	Plastics	Liquid Crystal Display (LCD)

Ludlum Measurements, Inc. products that have been placed on the market after August 13, 2005, have been labeled with a symbol recognized internationally as the “crossed-out wheeled bin,” which notifies the consumer that the product is not to be mixed with unsorted municipal waste when discarding. Each material must be separated. The symbol will be placed near the AC receptacle, except for portable equipment where it will be placed on the battery lid.

The symbol appears as such:



Section 10

Parts List

	<u>Reference</u>	<u>Description</u>	<u>Part Number</u>
Model 12 Survey Meter	UNIT	Completely Assembled Model 12 Survey Meter	48-1609
Main Board, Drawing 464 x 275	BOARD	Completely Assembled Main Circuit Board	5464-275
CAPACITORS	C1	47pF, 100V	04-5660
	C2	0.1 μ F, 35V-T	04-5755
	C3	0.0047 μ F, 100V	04-5669
	C4	NOT USED	
	C5	0.1 μ F, 35V-T	04-5755
	C6	2.2 μ F, 20V	04-5790
	C7	0.022 μ F, 50V	04-5667
	C8	1 μ F, 16V	04-5701
	C9	10 μ F, 10V-DT	04-5766
	C10	100pF, 100V	04-5661
	C11-C12	68 μ F, 10V	04-5654
	C13	2.2 μ F, 20V	04-5790
	C14	470pF, 100V	04-5668
	C15	0.1 μ F, 25V	04-5744
	C16	100pF, 3KV	04-5532
	C17	47 μ F, 10V	04-5666
	C18	470pF, 100V	04-5668
	C19	0.001 μ F, 3KV	04-5632
	C20	10 μ F, 10V	04-5766
	C21	0.01 μ F, 50V	04-5664
	C30	10 μ F, 10V	04-5766
	C31	1 μ F, 16V	04-5701
	C32	470pF, 100V	04-5668

	<u>Reference</u>	<u>Description</u>	<u>Part Number</u>
TRANSISTORS	Q1	MMBT3904LT1	05-5841
	Q2	MMBT4403LT1	05-5842
	Q3-Q4	MMBT3904LT1	05-5841
VOLTAGE REGULATOR	VR1	LT1460KC53-2.5	05-5867
	VR2	TPS76038	05-5912
INTEGRATED CIRCUITS	U1-U3	MAX4542ESA	06-6453
	U4-U5	CMXT3904	05-5888
	U6	CMXT3906	05-5890
	U7	MAX4541ESA	06-6452
	U8	MAX985EUK-T	06-6459
	U9	CD74HC4538M	06-6297
	U10	LMC7111BIM5X	06-6410
	U11	LT1304CS8	06-6394
	U12	MIC1557BM5	06-6457
	U13	LMC7111BIM5X	06-6410
	U14	TPS76050	05-5913
	U15	CMXT3906	05-5890
	U16	MAX4541ESA	06-6452
	DIODES	CR2	CMSH1-40M
CR3		CMPD2005S	07-6468
SWITCHES	SW1	CENTRAL-2P6P	08-6761
	SW2	TP11LTCQE	7464-186
	SW3-SW4	7101SDCQE	08-6781
	SW5	TP11LTCQE	7464-186
POTENTIOMETERS / TRIMMERS	R33	250K, 64W254, $\times 100$	09-6819
	R34	250K, 64W254, $\times 10$	09-6819
	R35	500K, 64W504, $\times 1$	09-6850
	R36	250K, 64W254, $\times 0.1$	09-6819
	R38	100K, 64W104, HV SET	09-6813
	R47	1M, 64W105, NAME	09-6814
	R49	10K, 3266 \times 1-103, HV METER ADJ	09-6822

	<u>Reference</u>	<u>Description</u>	<u>Part Number</u>
RESISTORS			
	R1-R5	200K, 1/8W, 1%	12-7992
	R6	8.25K, 1/8W, 1%	12-7838
	R7	10K, 1/8W, 1%	12-7839
	R8	2.37K, 1/8W, 1%	12-7861
	R9-R11	10K, 1/8W, 1%	12-7839
	R12	1K, 1/4W, 1%	12-7832
	R13	10K, 1/8W, 1%	12-7839
	R14	4.75K, 1/8W, 1%	12-7858
	R15	249K, 1/4W, 1%	12-7862
	R16	10K, 1/8W, 1%	12-7839
	R17	1K, 1/8W, 1%	12-7832
	R18	4.75K, 1/8W, 1%	12-7858
	R19	2K, 1/8W, 1%	12-7926
	R20	100K, 1/8W, 1%	12-7834
	R21	249K, 1/4W, 1%	12-7862
	R22	1M, 1/8W, 1%	12-7844
	R23	124K, 1/4W, 1%	12-7032
	R24	14.7K, 1/8W, 1%	12-7068
	R25	200K, 1/4W, 1%	12-7992
	R26	100K, 1/4W, 1%	12-7834
	R27	68.1K, 1/8W, 1%	12-7881
	R28	100K, 1/8W, 1%	12-7834
	R29	1K, 1/8W, 1%	12-7832
	R30	100K, 1/8W, 1%	12-7834
	R31	475K, 1/8W, 1%	12-7859
	R32	100K, 1/8W, 1%	12-7834
	R37	200K, 1/4W, 1%	12-7992
	R39	1M, 1/4W, 1%	12-7844
	R40	10K, 1/4W, 1%	12-7839
	R41-R42	100K, 1/4W, 1%	12-7834
	R43	10K, 1/4W, 1%	12-7839
	R44	1K, 1/4W, 1%	12-7832
	R45	475K, 1/4W, 1%	12-7859
	R46	10K, 1/4W, 1%	12-7839
	R48	1M, 1/4W, 1%	12-7844
	R50	1K, 1/4W, 1%	12-7832
CONNECTORS			
	P1	640456-5 - MTA100	13-8057
	P2	640456-6 - MTA100	13-8095
	P3	640456-2 - MTA100	13-8073

	<u>Reference</u>	<u>Description</u>	<u>Part Number</u>
	P4	640456-4 - MTA100	13-8088
	P5	DET PAD-RD120	7464-270
	P6	HV PAD-RD120	7464-270
INDUCTORS	L1	22 μ H	21-9808
HV Power Supply Board, Drawing 464 x 243	BOARD	Completely Assembled HV Power Supply Board	5464-243
CAPACITORS	C1-C2	0.01 μ F, 3KV, 2%	04-5762
	C3-C22	0.01 μ F, 500V	04-5696
	C23	0.1 μ F, 50V	04-5663
	C24	68 μ F, 10V	04-5654
	C25	NOT USED	*
INTEGRATED CIRCUITS	U1	LMC7111BIM5X	06-6410
	U2	LT1304CS8	06-6394
DIODES	CR1-CR10	CMPD2005S	07-6468
	CR11	CMSH1-40M	07-6411
RESISTORS	R2-R3	750K, 1/4W, 1%	12-7882
	R4-R5	500M, 3KV, 2%	12-7031
	R6	1M, 1/4W, 1%	12-7844
	R7	10K, 1/4W, 1%	12-7839
	R8	1M, 1/4W, 1%	12-7844
	R9	953K, 1/8W, 1%	12-7950
	R10	10 Ohm, 1W, 1%	12-7952
	R11-R12	150K, 1/4W, 1%	12-7833
	R13	100K, 1/4W, 1%	12-7834
CONNECTOR	P1	640456-4 MTA100x4	13-8088
	P2	CON 1	18-9238
TRANSFORMER	T1	31032R, Midcom	21-9925

	<u>Reference</u>	<u>Description</u>	<u>Part Number</u>
Wiring Diagram, Drawing 464 x 309 CONNECTORS	J1	MTA100×5, MAIN BOARD 5464-275	13-8057
	J2	MTA100×6, OPTIONAL 5464-275	13-8095
	J3	MTA 100×2, MAIN BOARD 5464-275	13-8073
	J4	MTA100×4, MAIN BOARD 5464-275	13-8088
	J5	MAIN BOARD 5464-275	**
	J6	MAIN BOARD 5464-275	**
	*	DETECTOR CONNECTOR, (RECPT-"C" SOLDERLESS)	4478-049
AUDIO	DS1	UNIMORPH, TEC-3526-PU	21-9251
BATTERIES	B1-B2	"D" CELL BATTERY	21-9313
METER	M1	PORT BEZEL W/ MVMNT ASSY	4363-188
MISCELLANEOUS	*	RANGE KNOB	08-6613
	*	PORTABLE BATTERY NEGATIVE CONTACT ASSY	2001-065
	*	PORTABLE BATTERY POSITIVE CONTACT ASSY	2001-066
	*	PORTABLE BATTERY LID WITH STAINLESS CONTACT	2009-036
	*	CAN GASKET	22-9773

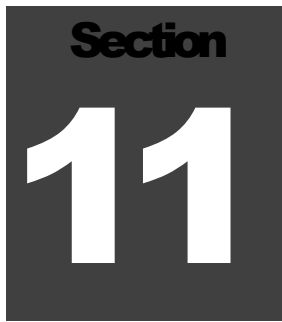
A dark gray square containing the word "Section" in a bold, sans-serif font at the top, and the number "11" in a large, white, bold, sans-serif font below it.

Drawings

MAIN CIRCUIT BOARD, Drawing 464 × 275 (3 sheets)

MAIN CIRCUIT BOARD LAYOUT, Drawing 464 × 276 (2 sheets)

HV POWER SUPPLY BOARD, Drawing 464 × 243

HV POWER SUPPLY BOARD LAYOUT, Drawing 464 × 244 (2 sheets)

WIRING DIAGRAM, Drawing 464 × 309

1

2

3

4

5

A

A

B

B

C

C

D

D

E

E

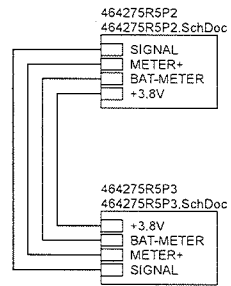

		PO Box 810	
		501 Oak Street Sweetwater, Texas 75556 U.S.A. 1-800-622-0828	
Drawn: MC	11/21/2007	Title: MAIN BOARD	
Design: DL	11/21/2007	Model: 12	
		Board#: 5464-275	
Approved: <i>[Signature]</i>	11/21/07	Sheet: 1 of 3	Series
Print Date: 7/17/2017 4:57:41 PM	Rev: 5	464	275
W:\Project\U\MMW 12545-275\Rev9\464275RSP1.SchDoc			

1

2

3

4

5

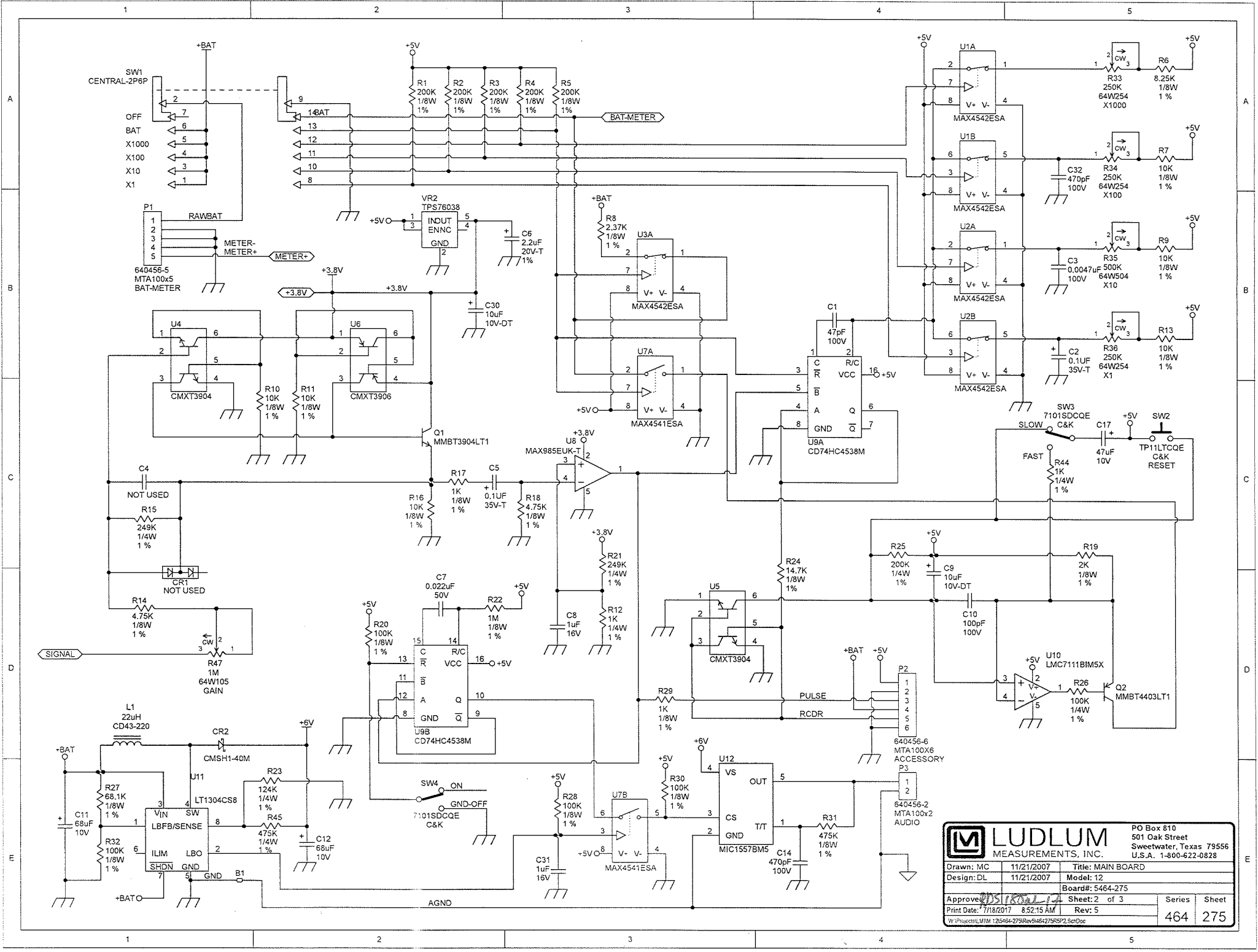

LUDLUM
MEASUREMENTS, INC.

PO Box 810
501 Oak Street
Sweetwater, Texas 79556
U.S.A. 1-800-622-0828

Drawn: MC	11/21/2007	Title: MAIN BOARD
Design: DL	11/21/2007	Model: 12
Approved: <i>[Signature]</i>		Sheet: 2 of 3
Print Date: 7/18/2017 8:52:15 AM	Rev: 5	Series
W:\Projects\125484-279\Rev0452\75RSP2_SchDoc		464 275

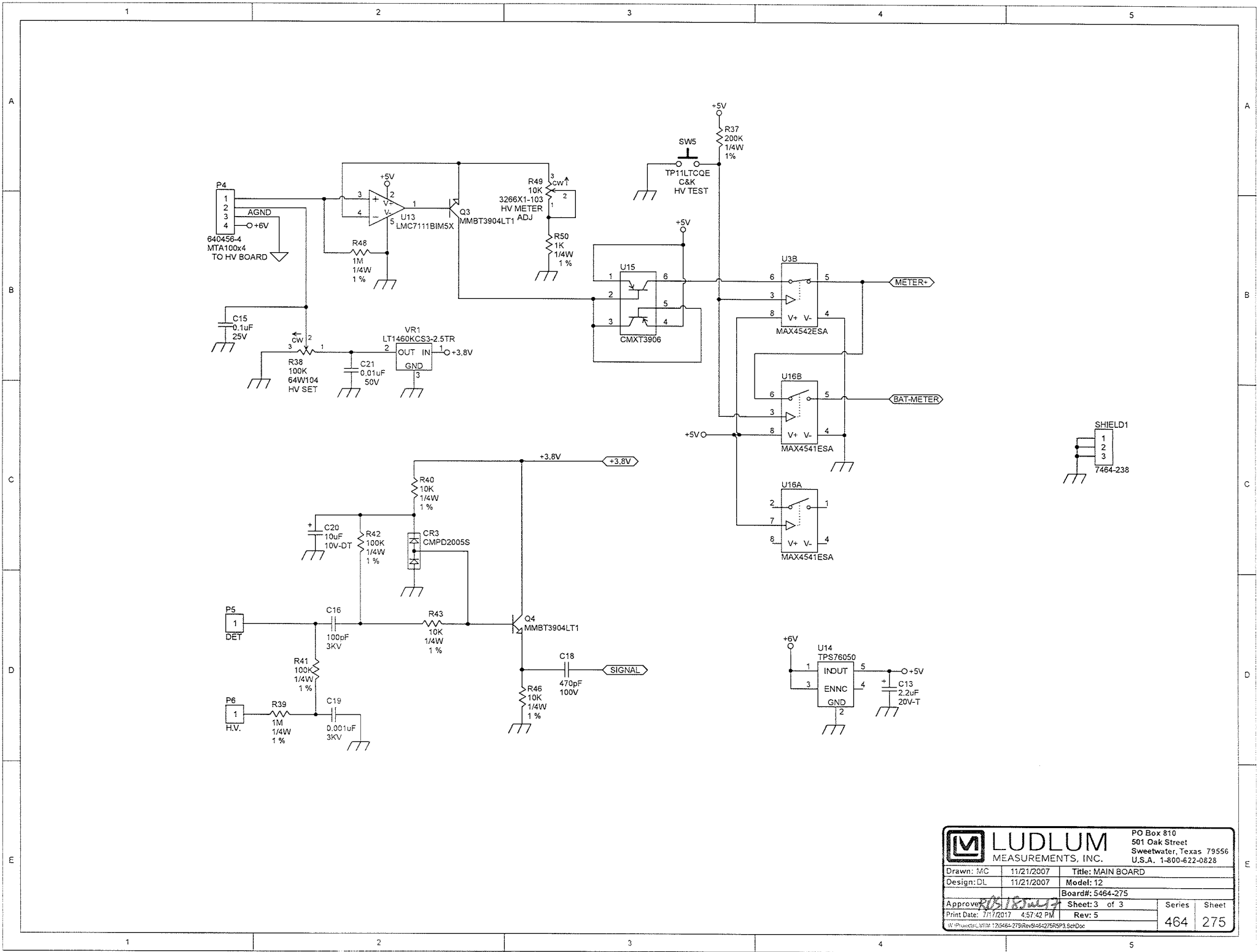

		PO Box 810 501 Oak Street Sweetwater, Texas 79556 U.S.A. 1-800-622-0828	
		Design: MC	11/21/2007
Design: DL	11/21/2007	Model: 12	
Approved:		Board#: 5464-275	
Print Date: 7/17/2017 4:57:42 PM	Rev: 5	Sheet: 3 of 3	Series: Sheet
W:\Projects\11M\125486-275\Rev9\464275RSP3.SchDoc		464	275

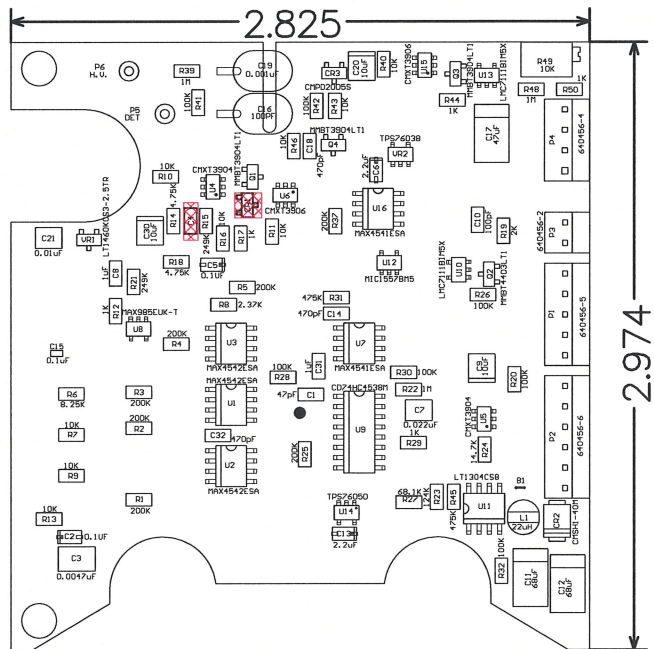

LUDLUM MEASUREMENTS, INC. U.S.A. 1-800-622-0828
 PO Box 810
 501 Oak Street
 Sweetwater, TX 79556

Title: MAIN BOARD			
Drawn: MC	11/21/2007	Model: 12	
Design: DL	11/21/2007	Board#: 5464-275	
Approve: <i>RJS</i>	<i>2/10/08</i>	Rev: 5	
Print Date: 12/11/2012 5:27:42 PM		SCALE: 1.00	Series 464
		Top Overlay	Sheet 276

W:\Projects\LM\MM 12\5464-275\Rev5\464275R5_Manual.PcbDoc

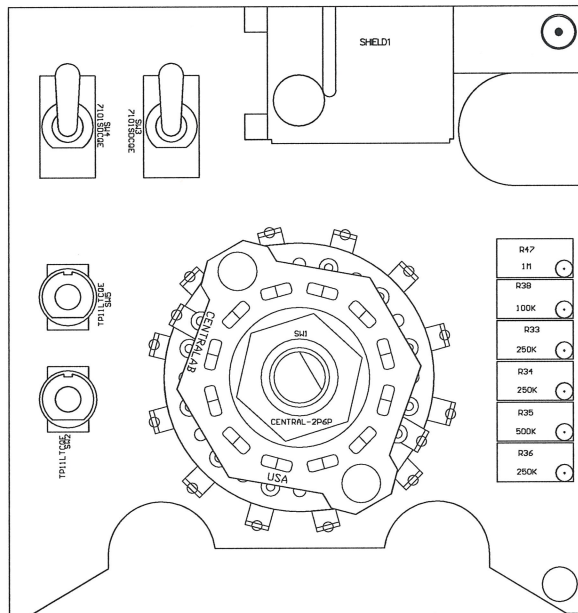

LUDLUM MEASUREMENTS, INC. PO Box 810
501 Oak Street
Sweetwater, TX 79556
U.S.A. 1-800-622-0828

Title: MAIN BOARD

Drawn: MC	11/21/2007	Model: 12
Design: DL	11/21/2007	Board#: 5464-275
Approve: <i>DL</i>	<i>11/21/2007</i>	Rev: 5
Print Date: 12/11/2012 5:27:44 PM		SCALE: 1.00 Series 464 Sheet 276

W:\Projects\LM\MM 12\5464-275\Rev5\464275R5_Manual.PcbDoc

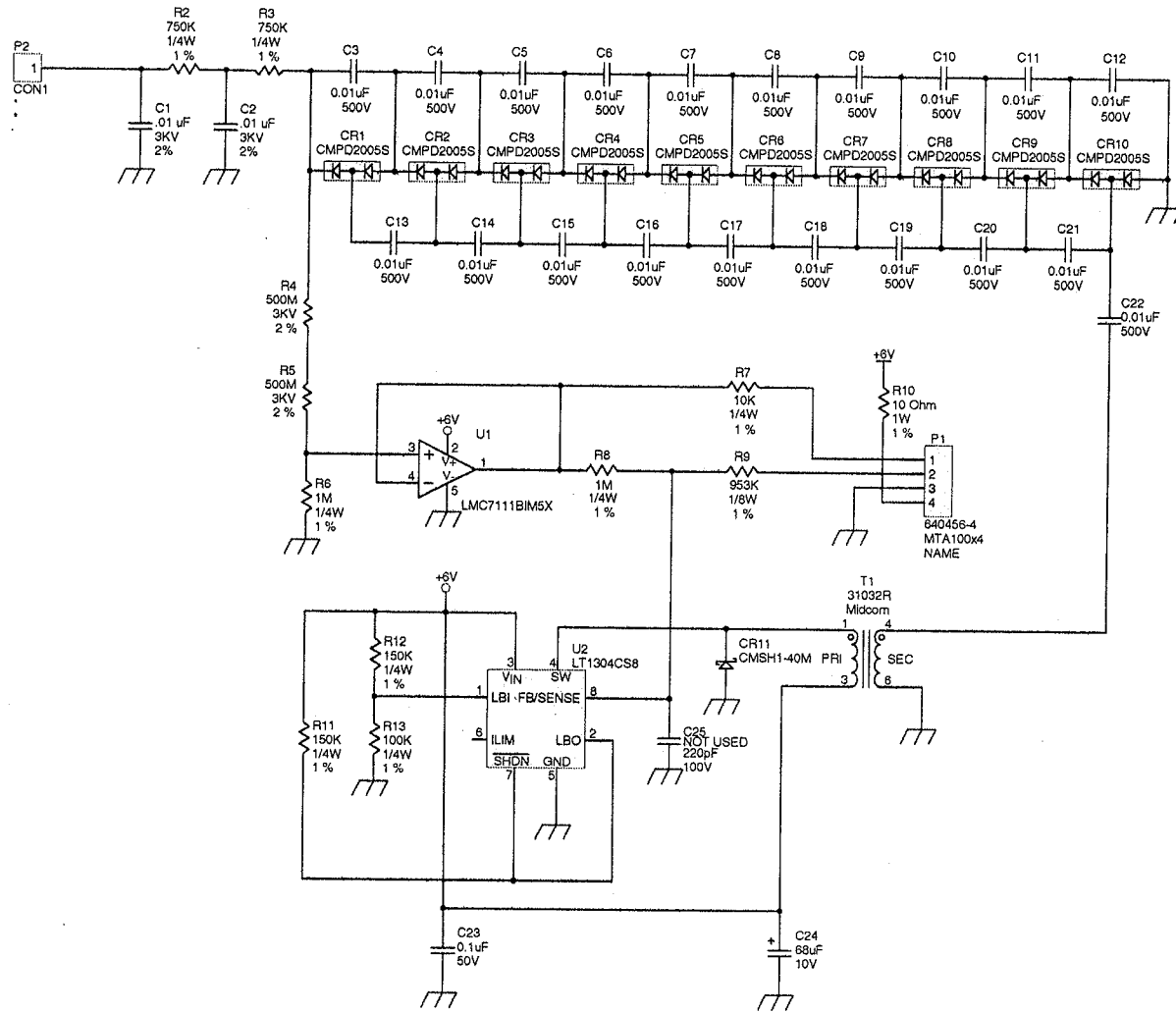

LUDLUM MEASUREMENTS, INC.		PO Box 510 501 Oak Street Sweetwater, Texas 79556 U.S.A. 1-800-622-0828	
Drawn: JK	06-DEC-04	Title: HV POWER SUPPLY BOARD	
Design: DL	06-DEC-04	Model: M12/M12-4	
Check:		Board#: 5464-243	
Approve: <i>R. BILGUS</i>	11-Aug-2005	Sheet: 1 of 1	Series
14:49:22	11-Aug-2005	Rev:	464 243
<small>X:\Projects\LWT\Tom\5464\M12\Doc - Documents\5464-243\Rev2.0\464243.sch</small>			

TopLayer (Scale 2.5:1)

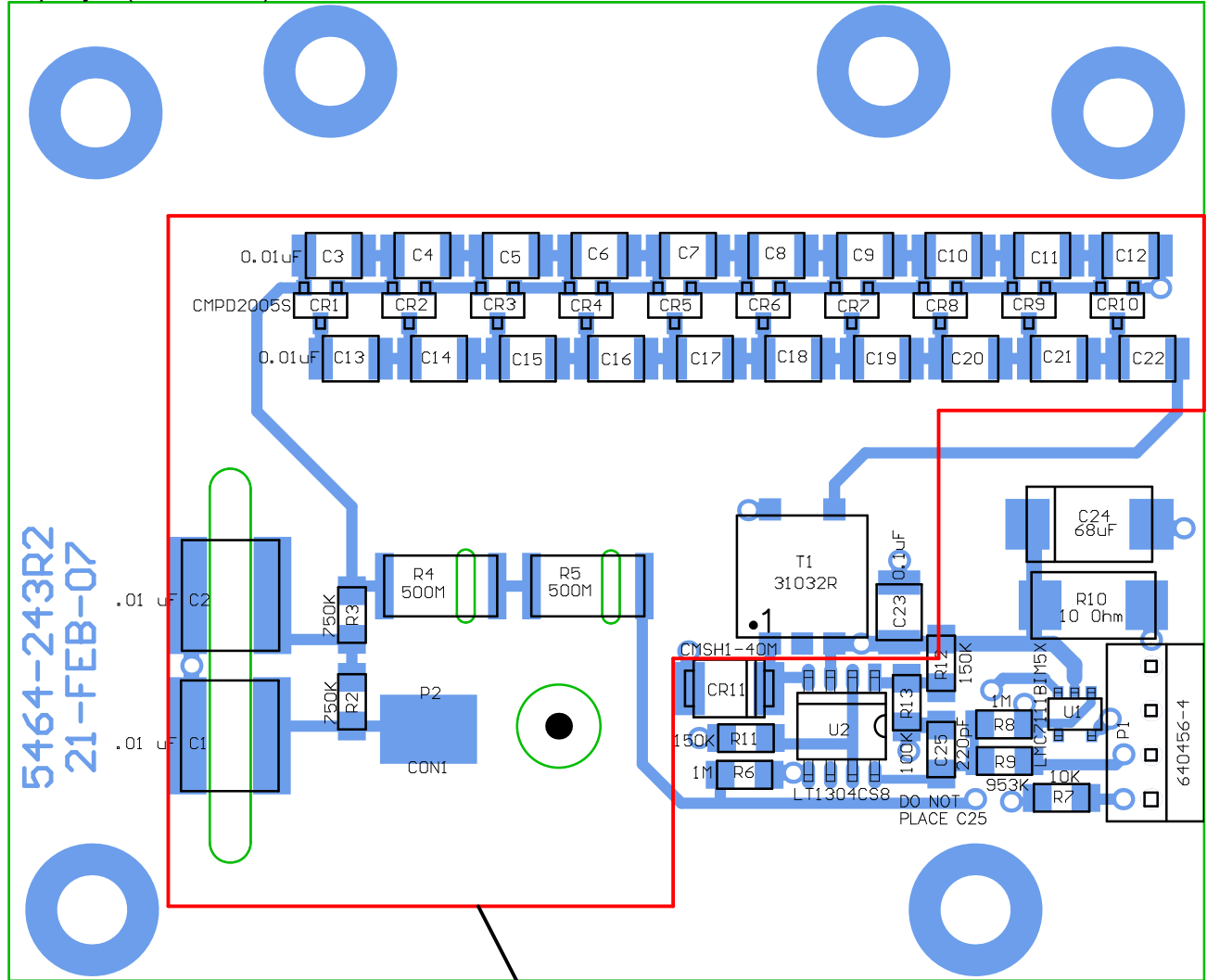



5464-243R2
21-FEB-07

APPLY HOT MELT GLUE HERE

 LUDLUM MEASUREMENTS				
Desc: HV POWER SUPPLY BOARD				
Design: DL	Date: 02/21/2007		Rev:	2
Drawn: PAB	Date: 4/19/2024	SHEET	SERIES	SHEET
Apr: <i>[Signature]</i>	Date: 5/16/2025	1 of 3		464 244
W:\Projects\LM\12\5464-243\Rev2\464243R2.PcbDoc				

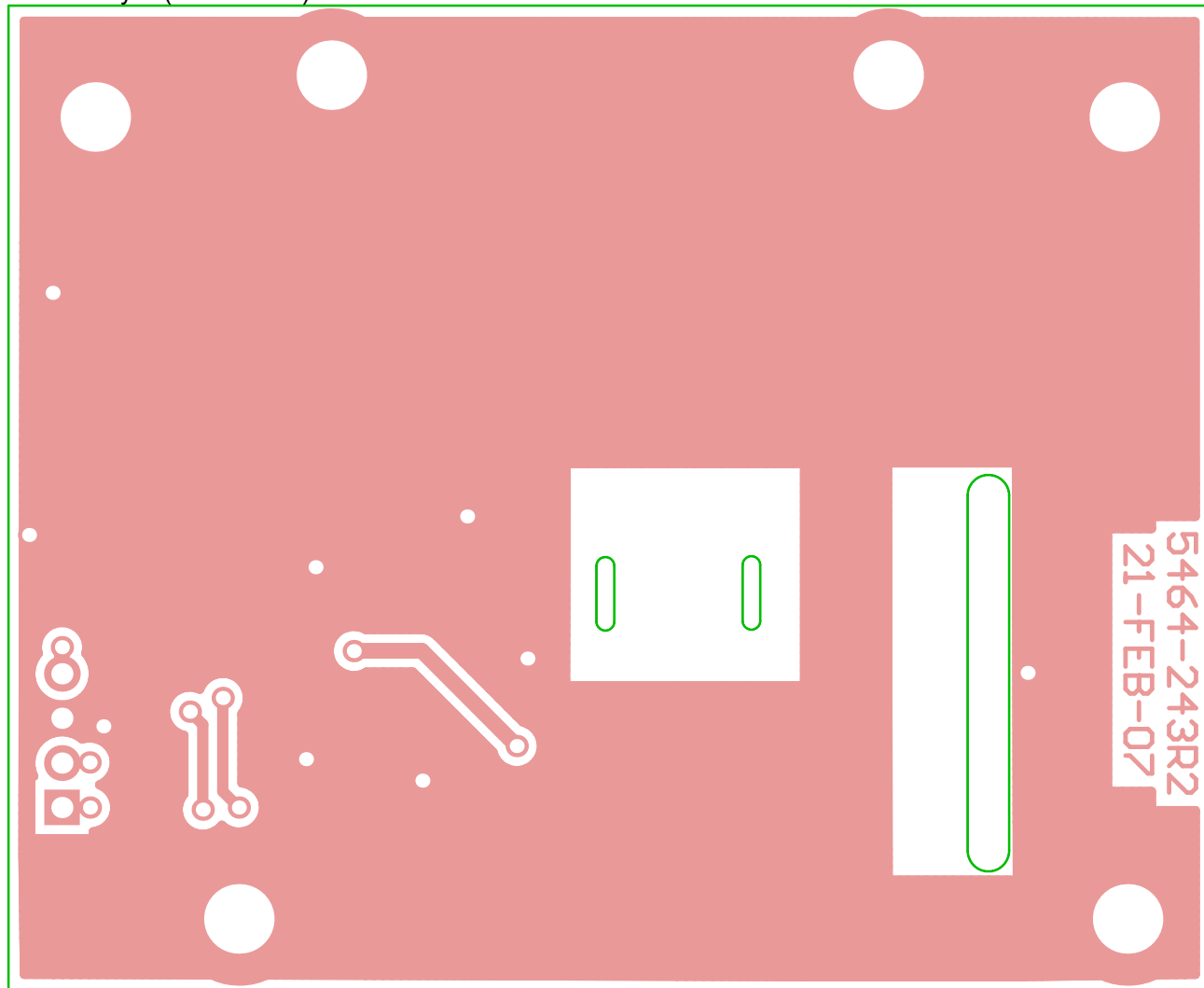
BottomLayer (Scale 2.5:1)



 LUDLUM MEASUREMENTS				
Part: 5464-243		Model: 12/12-4		
Desc: HV POWER SUPPLY BOARD				
Design: DL	Date: 02/21/2007	Rev:	2	
Drawn: PAB	Date: 4/19/2024	SHEET	SERIES	SHEET
		2 of 3	464	244
W:\Projects\LM\12\5464-243\Rev2\464243R2.PcbDoc				

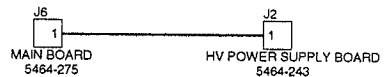
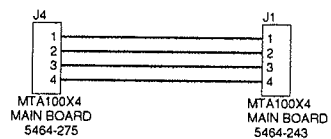
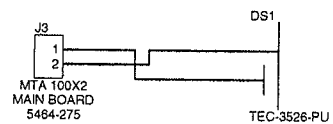
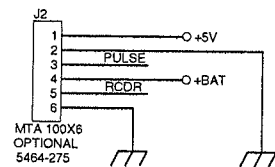
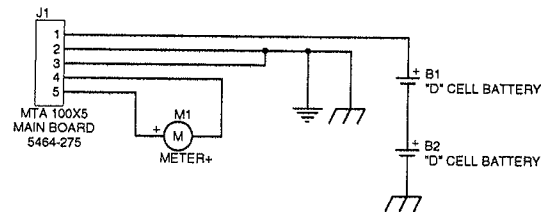

		LUDLUM		PO Box 810 501 Oak Street Sweetwater, Texas 79556 U.S.A. 1-800-622-0828	
Drawn: JK	01-JUN-04	Title: WIRING DIAGRAM			
Design: DL	01-JUN-04	Model: 12			
		Board#: 464-309			
Approve: <i>[Signature]</i>	10:58:14	28-Dec-2005	Sheet: 1 of 1	Series	Sheet
			Rev: 3.0	464	309
464X309.wd					