

**LUDLUM MODEL 3500-1000RWM  
RADIATION WASTE MONITOR  
INSTALLATION MANUAL**

August 2001

## **RECEIVING CONDITION EXAMINATION**

Be sure to verify that the shipping carton is received in good condition with no visible damage. Should the instrument be received in a damaged condition, save the shipping container and the packing material and request an immediate inspection by the carrier.

## **RETURN OF GOODS TO MANUFACTURER**

If equipment needs to be returned to Ludlum Measurements, Inc. for repair or calibration, please send to the address below. All shipments should include documentation containing return shipping address, customer name, telephone number, description of service requested, and all other necessary information. Your cooperation will expedite the return of your equipment.

**LUDLUM MEASUREMENTS, INC.  
ATTN: REPAIR DEPARTMENT  
501 OAK STREET  
SWEETWATER, TX. 79556  
800-622-0828(USA) 915-235-5494  
FAX: 915-235-4672**

## **STATEMENT OF WARRANTY**

Ludlum Measurements, Inc. warrants the products covered in this manual to be free of defects due to workmanship, material, and design for a period of twelve months from the date of delivery. The calibration of a product is warranted to be within its specified accuracy limits at the time of shipment. In the event of instrument failure, notify Ludlum Measurements to determine if repair, recalibration, or replacement is required.

This warranty excludes the replacement of photomultiplier tubes, G-M and proportional tubes, and scintillation crystals which are broken due to excessive physical abuse or used for purposes other than intended.

There are no warranties, express or implied, including without limitation any implied warranty of merchantability or fitness, which extend beyond the description of the face there of. If the product does not perform as warranted herein, purchaser's sole remedy shall be repair or replacement, at the option of Ludlum Measurements. In no event will Ludlum Measurements be liable for damages, lost revenue, lost wages, or any other incidental or consequential damages, arising from the purchase, use, or inability to use product.

## **RETURN OF GOODS TO MANUFACTURER**

If equipment needs to be returned to Ludlum Measurements, Inc. for repair or calibration, please send to the address below. All shipments should include documentation containing return shipping address, customer name, telephone number, description of service requested, and all other necessary information. Your cooperation will expedite the return of your equipment.

**LUDLUM MEASUREMENTS, INC.  
ATTN: REPAIR DEPARTMENT  
501 OAK STREET  
SWEETWATER, TX 79556**

**800-622-0828 325-235-5494  
FAX 325-235-4672**

# TABLE OF CONTENTS

1. INSTALLATION OF RADIATION DETECTION SYSTEMS .....	4
2. INSTALLATION INSTRUCTIONS AND DRAWINGS .....	5
2.1 Parts List .....	5
2.2 Detector Mounting Bracket Installation .....	6
2.3 Electronics Mounting Bracket Installation .....	6
2.4 Detector Installation .....	7
2.5 Electronics Installation .....	8

## 1. INSTALLATION OF RADIATION DETECTION SYSTEMS

---

**INTRODUCTION** -- Your Ludlum Measurements, Inc. radiation monitor system is designed to protect you from radiation and costs incurred from the radiation. To be effective, though, the system must be installed correctly and the operators must be trained. The system is designed to be automatic, with very little operator intervention. Ludlum Measurements has personnel to help with the installation and to train users on radiation safety and equipment use.

Each vehicle should drive slowly through the detectors. When it is completely through the detectors, the microprocessor-based electronics will take a couple of seconds to decide if any excess radiation was present. When excess radiation is present, the alarm will be activated to alert the operators. A common practice is to run the vehicle through a second time to ensure that the gate monitor is activated twice. Then, portable detectors are usually used to locate the "hot" or radioactive material.

The following provide some general tips:

**Protection** -- A scrap yard is a rough environment and not everyone is a good driver. Protect the gate monitors because they are expensive to rebuild. Protection includes crash barriers, railings, and curbs if possible.

**Background Radiation** -- Survey the site prior to putting in the gate monitor. Asphalt can be made with naturally-occurring radioactive material (NORM), which can disrupt the sensitivity of the system. Also, don't pile NORM material next to the gate monitor.

**Slow the Traffic** -- Traffic just can't speed through and be adequately scanned. Any gate monitor has a frightening loss of sensitivity if the truck zooms through faster than 5 mph. We suggest a stop sign prior to the monitor, speed bumps, and a speed limit of 2-3 mph.

**Training** -- A system depends upon trained personnel to operate correctly. Personnel must be trained to use the equipment properly, respond to radiation alarms, identify the problem, and initiate the correct safety procedures if the radiation is above the measuring limits of the portable detector. Training should apply to everyone within the yard so that secondary checks may detect radioactive material. For example: if a lead-shielded source makes it through the gate monitor without detection, maybe someone that was trained might notice a radiation symbol or that there is an inordinate amount of lead in a small container.

# MODEL 3500-1000RWM RADIATION WASTE MONITOR

## 2. INSTALLATION INSTRUCTIONS AND DRAWINGS

---

The following instructions are for the standard installation where the system is located at the weigh scales of a facility. It can be configured for other areas if required.

### 2.1 Parts List for Standard Installation

The following list consists of all necessary materials that have been shipped with the Model 3500-1000RWM Gate Monitor System. Please verify that all parts have been included. If any parts are missing, contact LMI at 1-800-622-0828 and ask for customer service. We will be glad to send you any parts that have been mistakenly left out.

<u>PART</u>	<u>PART NO.</u>	<u>QUANTITY</u>
Model 3500-1000RWM Electronics	4384-297	1
Model 3500-1000RWM Electronics Mounting Bracket Kit	4384-142 7384-026	1 2
Includes:		
Mounting Brackets	17-8580	4
5/16 - 18 X 1" Screws	20-9049	8
5/16 Flat Washers	20-9121	4
5/16 Lock Washers	20-9120	4
5/16 Hex Head Nuts		
Model 44-128 Detectors with Protective Housings	47-2957	2
Detector Cables	8303-584	2
Red Strobe with Cable	4384-143	1
Check Source	01-5231	1
22-gauge wire nuts	20-9142	10

The following items will also need to be obtained by the user to complete the system installation.

<u>PART</u>	<u>QUANTITY</u>
10" channel or I-beam approximately 13' long. (Detector mounts)	2
5" pipe approximately 13' long (Guard posts) or equivalent	4
1" steel plate ( 8 1/2" x 6' )	2
1 1/2" rigid conduit with weather tight fittings	The amount of conduit is determined by the distance from the electronics and the detectors.
1/2" flexible weathertight conduit with fittings (4 ea. straight fittings; 2 ea. 90° fittings)	Approximately 8'
Concrete mix (for optional curb, add 10 yards)	Approximately 1 yards

## **2. INSTALLATION INSTRUCTIONS AND DRAWINGS**

---

### **2.2 Detector Mounting Bracket Installation**

1. Three detector brackets attach to the detector stand using 1/2" bolts. Alternatively, the detector can be mounted to 4"-6" pipe, using the clamps provided.
2. The detector is then attached to the brackets using 3 stainless steel clamps. Be sure that the LUDLUM label faces away from the stand.

### **2.3 Electronics Mounting Bracket Installation**

1. Unlock and open the front panel of the Model 3500-1000RWM electronics using the key that is provided.
2. Locate the four mounting holes in the bottom corners of the box and place one 5/16 - 18 X 1" screw in each hole.

**NOTE:** Be careful not to drop the screws into the electronics or damage the circuitry in any way. Many of the parts are delicate and cannot withstand much abuse.

3. Place a mounting bracket on each side of the electronics so that the flange faces out. Secure in place with the lock washers and nuts.
4. Close and lock the electronics front panel and place the key in a secure place. The instrument is now ready for installation.

## 2. INSTALLATION INSTRUCTIONS AND DRAWINGS

---

### 2.4 Detector Installation

To prepare the site for system installation, conduit will need to be run from the building where the electronics will be located to both sides of the scale or location of the detectors. In addition, three 1-ft. diameter X 3-ft. deep holes will need to be dug according to the installation drawings. The conduit should be run so that it meets with the center hole on each side of the vehicle passageway.

1. Place one 10" I-beam or equivalent in the center hole on each side of the scale on which to mount the detectors and infrared sensors.
2. Run the 1/2" rigid conduit from the building to the center hole on each side of the scale so that the end of the conduit is approximately 2 ft. above the surface of the ground. A short length of flexible conduit (2' - 4' long) can be used from the conduit stub and the detector.
3. Fill the center holes with concrete. Make sure that the poles are supported so that they remain perpendicular to the ground while the concrete is setting.
4. Place one 5" pole in each of the four remaining holes and fill the holes with concrete, making sure to support the poles so that they remain perpendicular to the ground while the concrete is setting.
5. The optional curb will also help protect the system. It requires approximately 10 yards of concrete.

<p><b>NOTE:</b> The concrete will need to set for approximately 24 - 48 hours to insure stability. If the weather is wet or cold, drying times may be longer.</p>
---

6. Note that the BNC connectors may be unscrewed from the black coaxial cable. See the drawing provided that shows cable end preparation.
7. Now pull the two cables from the scale house back into each side of the scale. Pull the detector cable through to the detector. Reattach the BNC connector to the cable and connect to the internal detector BNC coupling.



# MODEL 3500-1000RWM RADIATION WASTE MONITOR

## 2. INSTALLATION INSTRUCTIONS AND DRAWINGS

### 2.5 Electronics Installation

1. With the electronics mounting brackets attached to the electronics, mount the unit on the wall where it will be convenient for the user to reset the system in the event of an alarm.
2. Locate the cables for each detector.
3. Connect the cable for the detector on the left side of the vehicle passageway to the connector labeled "CHANNEL 1."
4. Connect the remaining detector cable to the connector labeled "CHANNEL 2."
5. Connect the red strobe cable to the connector labeled "RELAY OUT." The strobe can be placed outside the building, or in other locations within 50' of the electronics.
6. Connect the power cord to the connector labeled "115 VAC" (or 220 VAC).

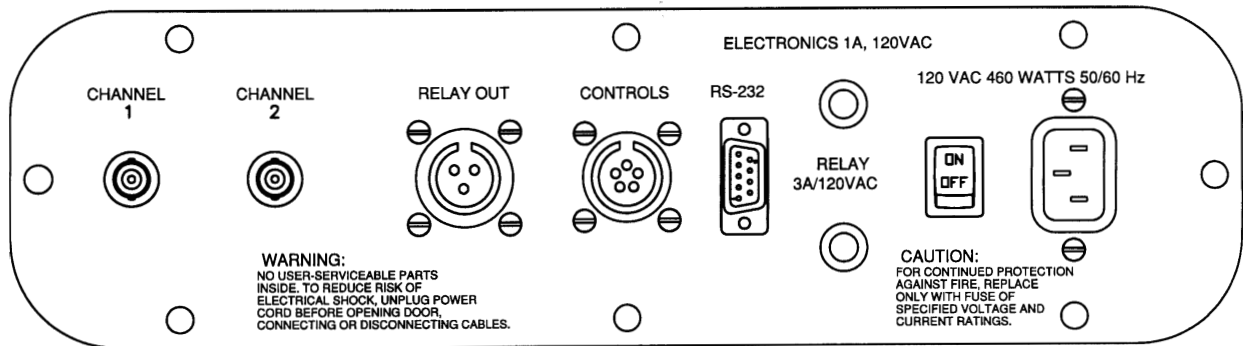

REV #	ALTERATIONS	DATE	BY
1	VALID	07-01-99	TJR

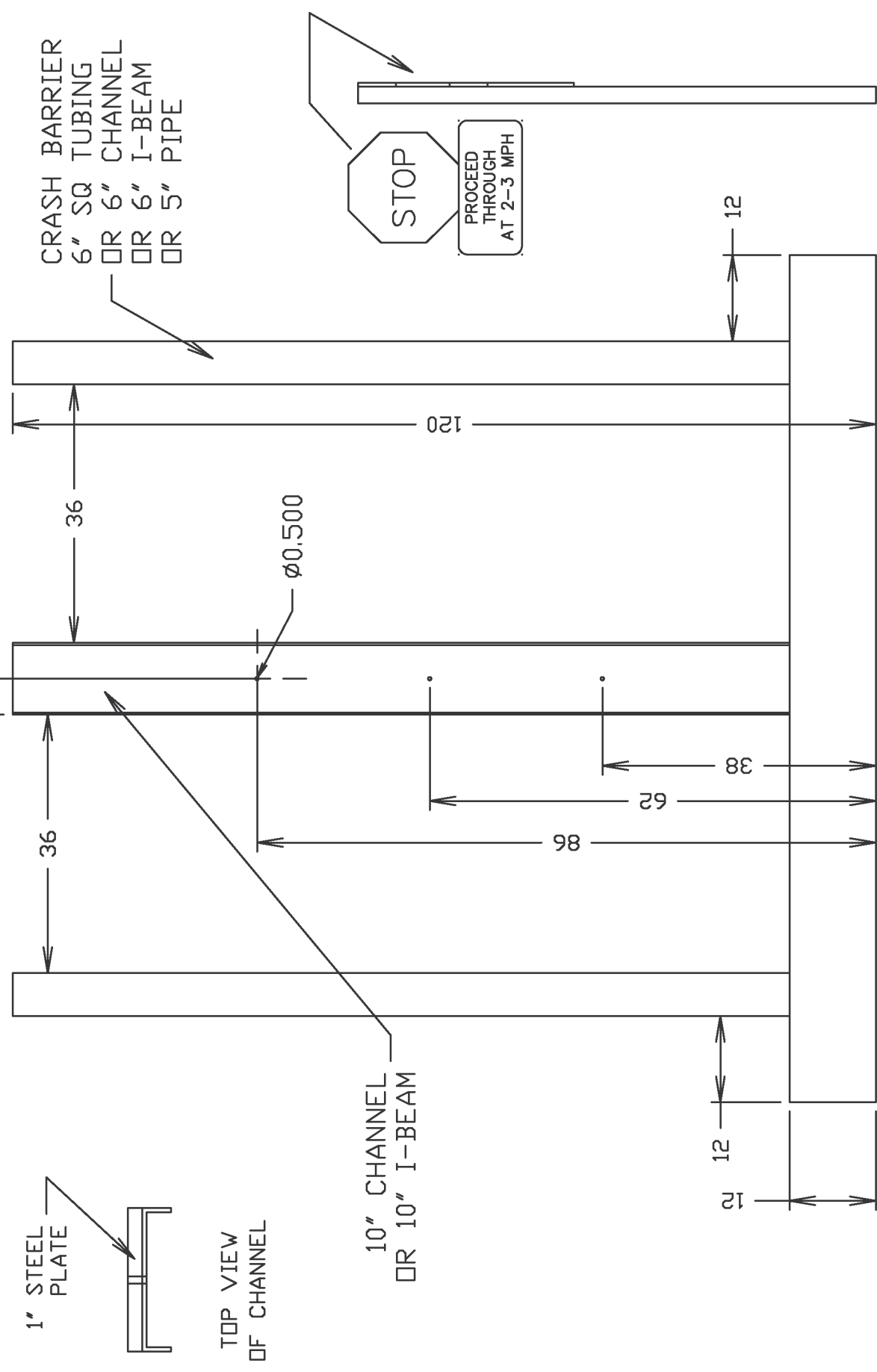

SEE ALSO SHEETS  
384 X 336 B,C,D,E

DRAWN	DATE	CHECKED	APPROVED
TJR	07-01-99		
TITLE: M 3500-1K RVM LOOKING AT DETECTOR		SERIES	SHEET
LUDLUM MEASUREMENTS, INC. 500 LUK STREET ANN ARBOR, MI 48106		384	336A

REV #	ALTERATIONS	DATE	BY
	VALID	10-22-98	JGW

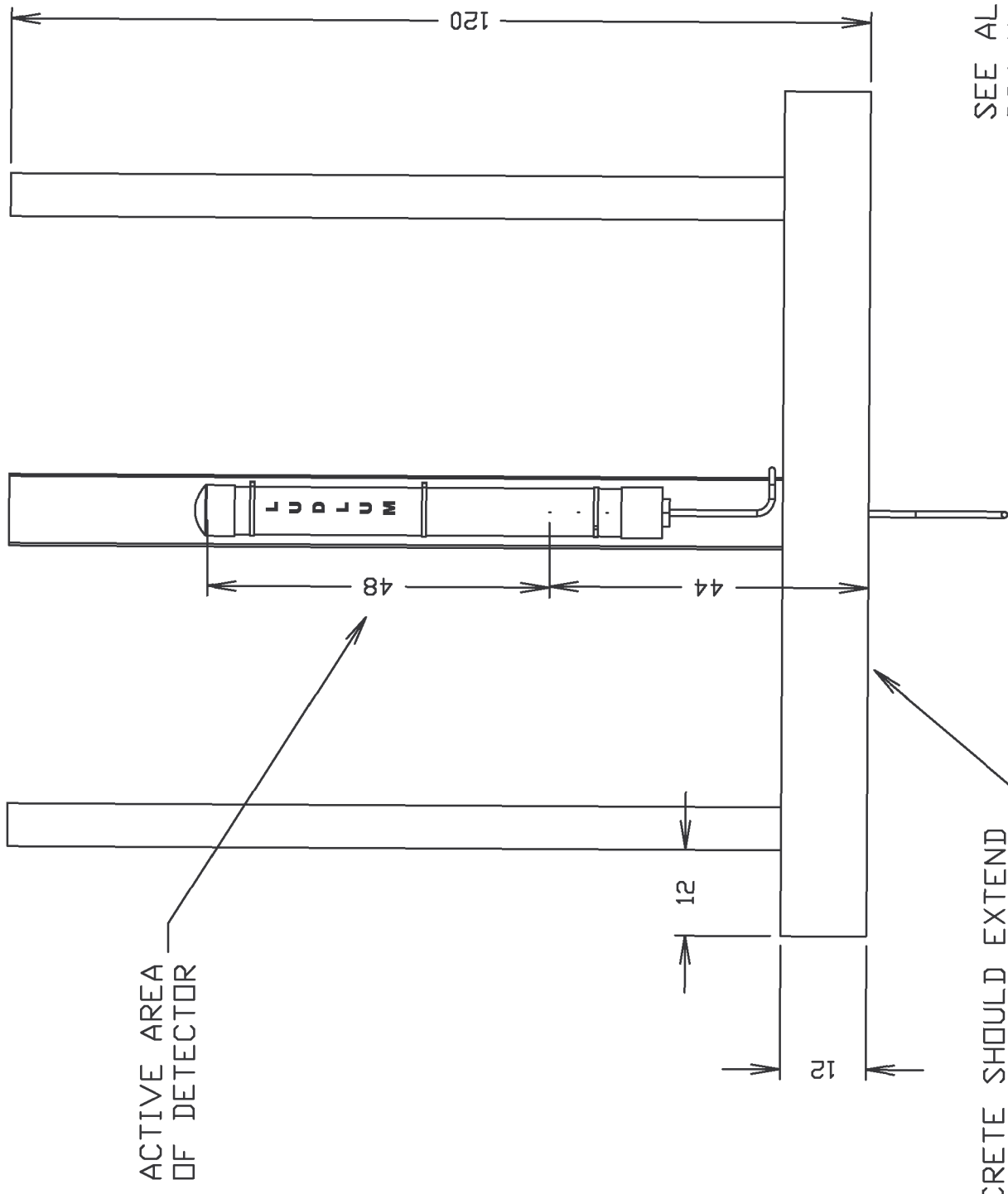

SEE ALSO SHEETS  
384 X 336 A,C,D,E

CONCRETE SHOULD EXTEND  
36" BELOW GROUND LEVEL

DWN DATE	CHECKED	APPROVED
JGW 10-22-98		
TITLE: M 3500-1K RVM LOOKING AT DETECTOR		
LUDLUM MEASUREMENTS, INC. 501 5TH STREET MILWAUKEE, WISCONSIN 53212		
SHEET	384	336B

REV #	ALTERATIONS	DATE	BY
	VALID	12-23-98	JGW

1" STEEL PLATE  
 10" WIDE FOR 10" CHANNEL  
 8.5" WIDE FOR 10" I-BEAM  
 APPROX. 68" LONG. MOUNT BOTTOM  
 EDGE 27" FROM GROUND OR 15" FROM TOP OF CURB

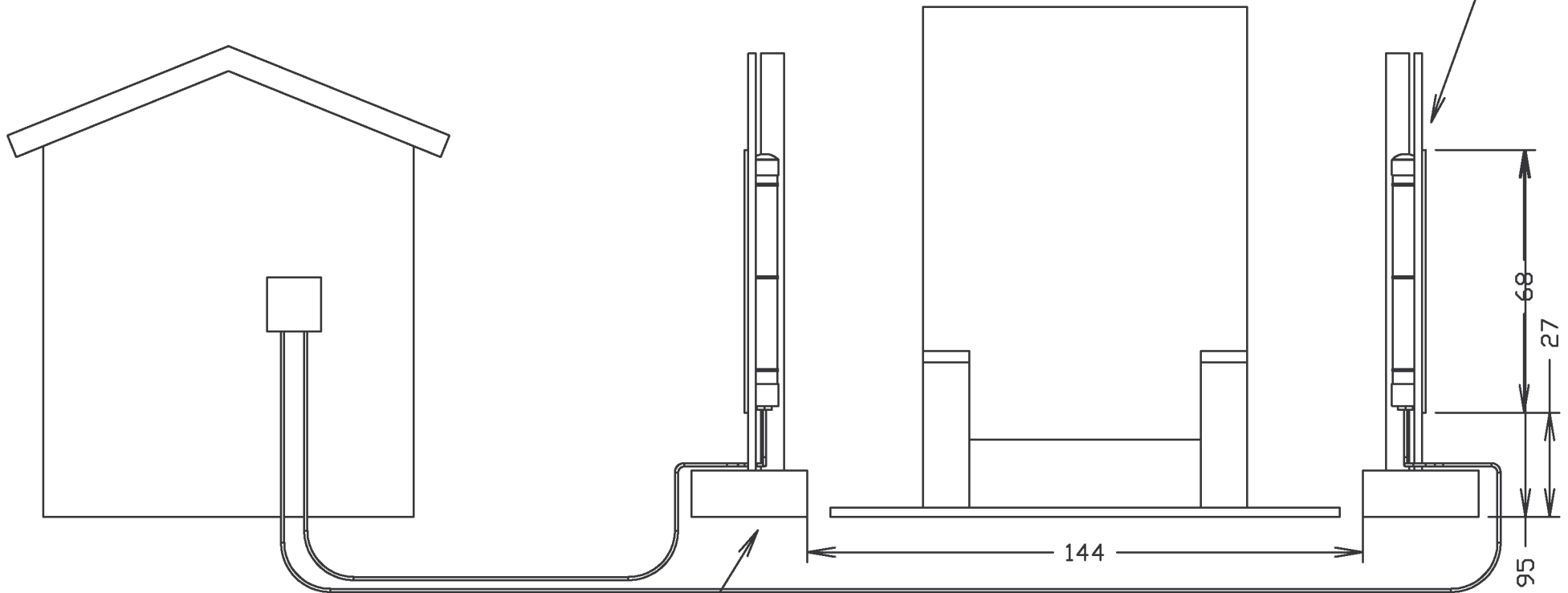

GROUND LEVEL.  
 CONCRETE SHOULD  
 EXTEND 36" BELOW  
 GROUND LEVEL.

1/2 CONDUIT FROM  
 SCALE HOUSE TO  
 DETECTOR

SEE ALSO SHEETS  
 384 X 336 A,B,D,E

DWN	DATE	CHECKED	APPROVED
JGW	12-23-98		
TITLE: M 3500-1K RWM LOOKING AT SCALE			
 LUDLUM MEASUREMENTS, INC. <small>501 OAK STREET</small>		SERIES	SHEET
		384	336C

REV #	ALTERATIONS	DATE	BY
	VALID	10-22-98	JGW

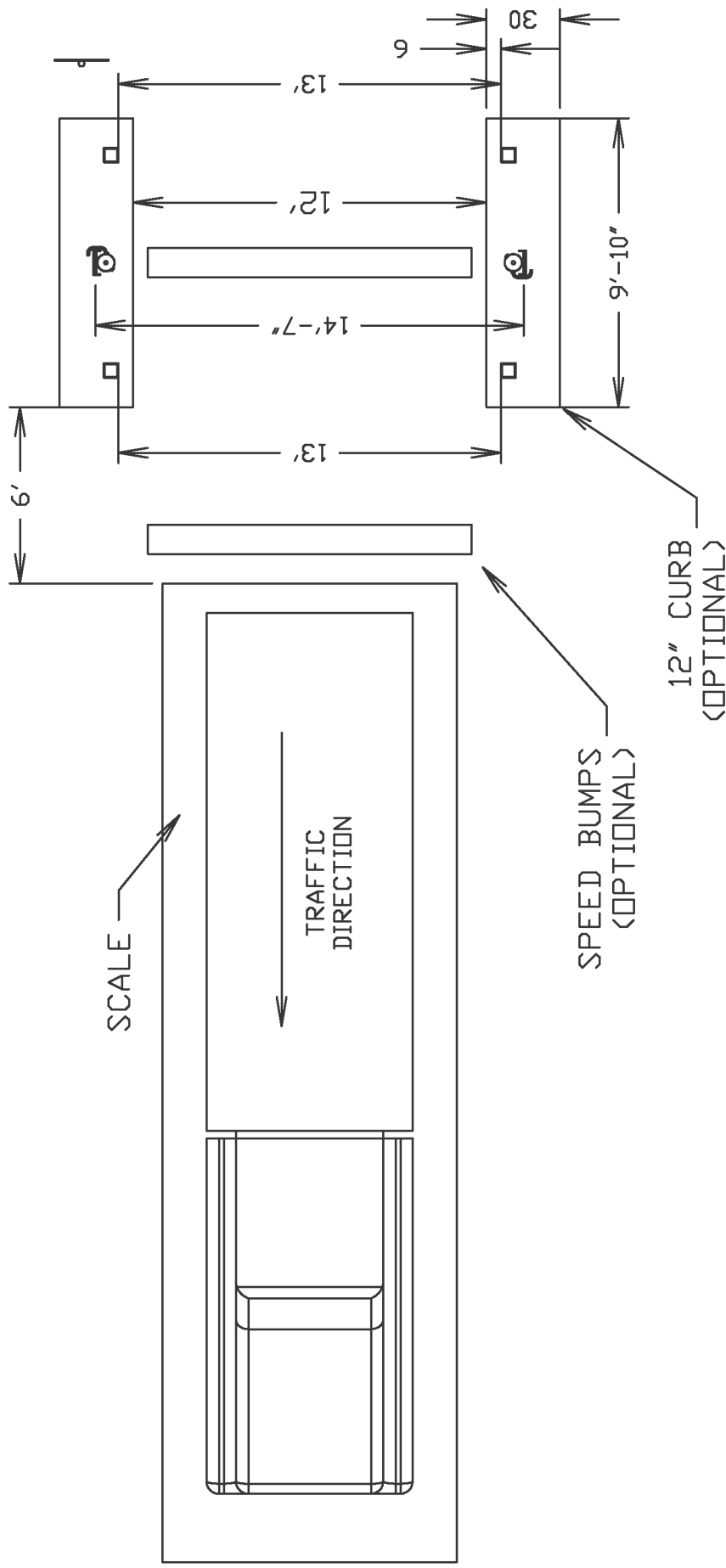

SEE ALSO SHEETS  
384 X 336 A,B,C,E

DRAWN DATE	CHECKED	APPROVED
JGW 10-22-98		
TITLE: M 3500-1K RVM AERIAL VIEW		
SERIES 384		
SHEET 336D		
		

REV #	ALTERATIONS	DATE	BY
	VALID	12-23-98	JGW

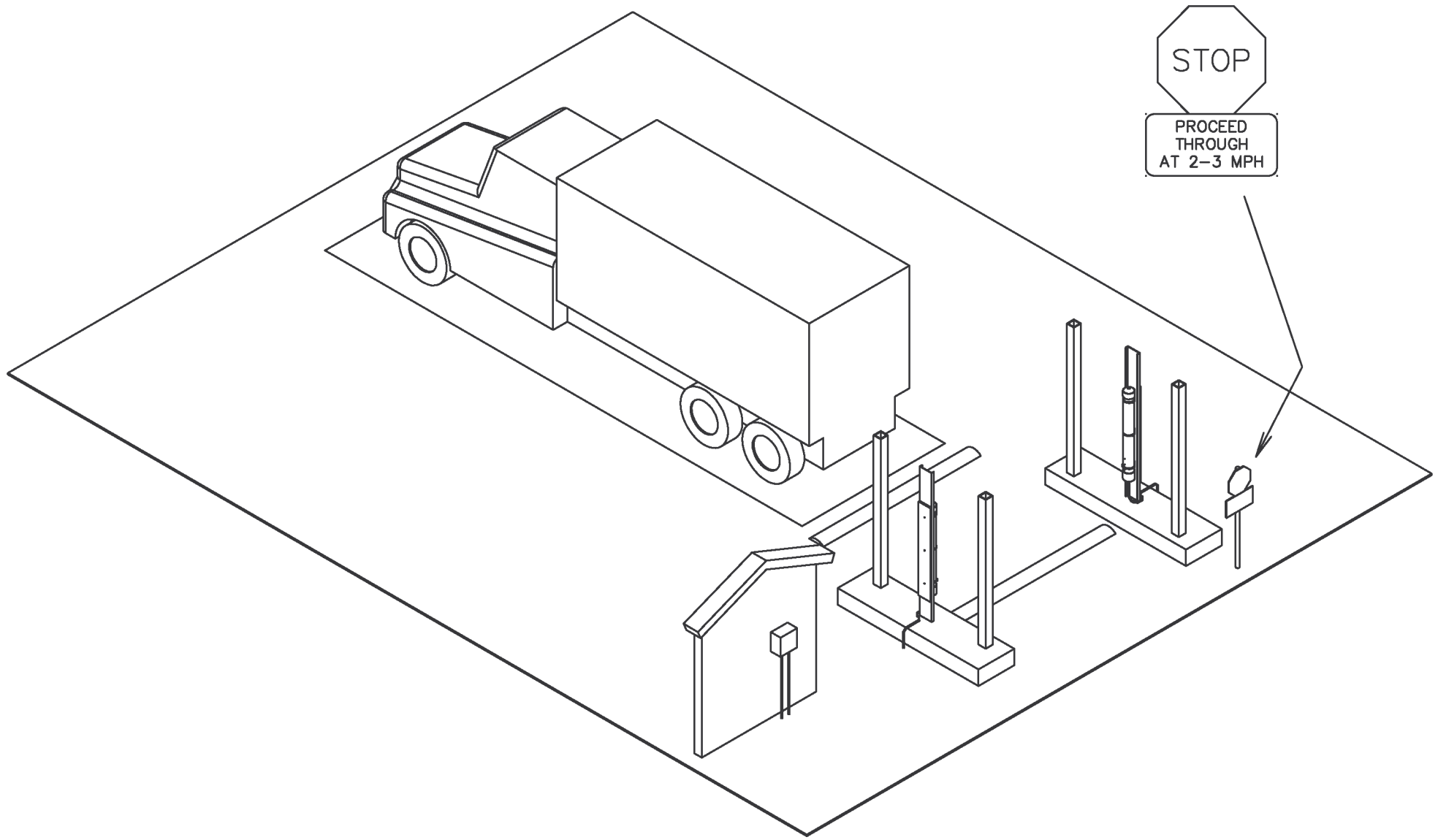

STOP

PROCEED THROUGH AT 2-3 MPH

SHOWN WITH OPTIONAL CURB AND SPEED BUMPS

SEE ALSO SHEETS  
384 X 336 A,B,C,D

DWN JGW	DATE 12-23-98	CHECKED	APPROVED
TITLE: M 3500-1K RWM ISO VIEW			
 LUDLUM MEASUREMENTS, INC. 501 DAK STREET		SERIES 384	SHEET 336E

REV #	ALTERATIONS	DATE	BY
1	VALID	7-27-98	DDW

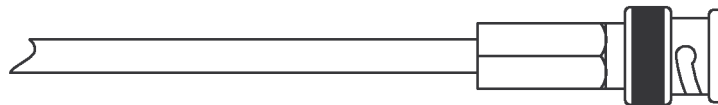
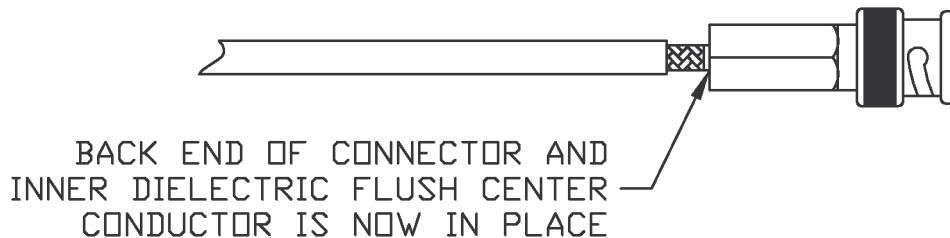
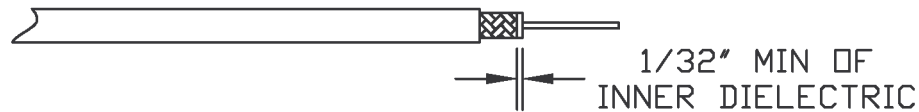
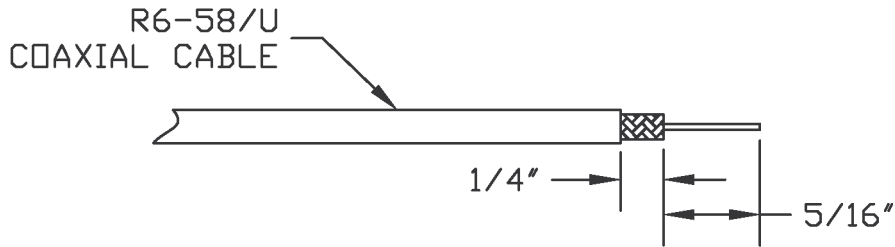

- ① TRIM CABLE AS SHOWN TAKING CARE NOT TO NICK THE CENTER CONDUCTOR OR OUTER BRAID
- ② TWIST THE OUTER BRAID IN A CLOCKWISE DIRECTION IN SUCH A MANNER THAT AT LEAST 1/32" OF INNER DIELECTRIC IS BARED, AND THE BRAID IS LEFT FLAT (STRAY OR LOOSE BRAID CAN CAUSE SHORTS).
- ③ GENTLY INSERT THE CENTER CONDUCTOR DOWN INTO THE BACK END OF THE CONNECTOR FEELING IT INTO THE GUIDE HOLE. WHEN THE CENTER CONDUCTOR IS NOT IN PLACE, APPROX 1/8" OF CENTER CONDUCTOR WILL SHOW.
- ④ FIRMLY PUSH THE CABLE HOME AS FAR AS POSSIBLE. THEN SCREW THE CONNECTOR ON THE CABLE IN A CLOCKWISE DIRECTION UNTIL IT STOPS.

LMI #13-8540

DWN	DATE	CHK	DATE	APP	DATE
DDW	7-27-98				
PART NUM: 7-27-98				SCALE: FULL <input checked="" type="checkbox"/> OTHER	
TITLE EASY-ON TWIST ON BNC CABLE ASSY					
LUDLUM MEASUREMENTS, INC. 301 OAK STREET SWEETWATER, TEXAS 79556			SERIES	SHEET	
			384	332	